

CST STUDIO SUITE 2011



CST MICROWAVE STUDIO | CST EM STUDIO
CST PARTICLE STUDIO | CST CABLE STUDIO | CST PCB STUDIO
CST MPHYSICS STUDIO | CST DESIGN STUDIO



CST STUDIO SUITE 2011 is the culmination of many years of research and development into the most accurate and efficient computational solutions for electromagnetic designs. It comprises CST's tools for the design and optimization of devices operating in a wide range of frequencies – static to optical. Analyses may include thermal and mechanical effects, as well as circuit simulation.

All programs are accessible through a common interface which facilitates multi-physics and co-simulation.

The CST STUDIO SUITE graphical user interface. 3D EM simulation of cancer treatment by RF thermoablation: a catheter is used to apply a 40 W signal at 375 MHz to a tumor in the liver. The bioheat equation solver is used for the realistic simulation of the resulting temperature distribution.

WHAT DO RFIDS, PARTICLE GUNS AND CAR ANTENNAS HAVE IN COMMON?

You can design all of these applications using CST STUDIO SUITE. It offers an extensive range of features and solvers suited to all kinds of electromagnetic (EM) problems. While you can customize the package for specific applications, you can also easily switch to other design projects, exploiting your experience with the interface, workflow, and methodology. The solver range includes: time domain, frequency domain, integral equation, asymptotic, fast resonant, eigenmode, static and stationary fields, charged particles, temperature, mechanical stress, and circuit simulation.

MARKETS

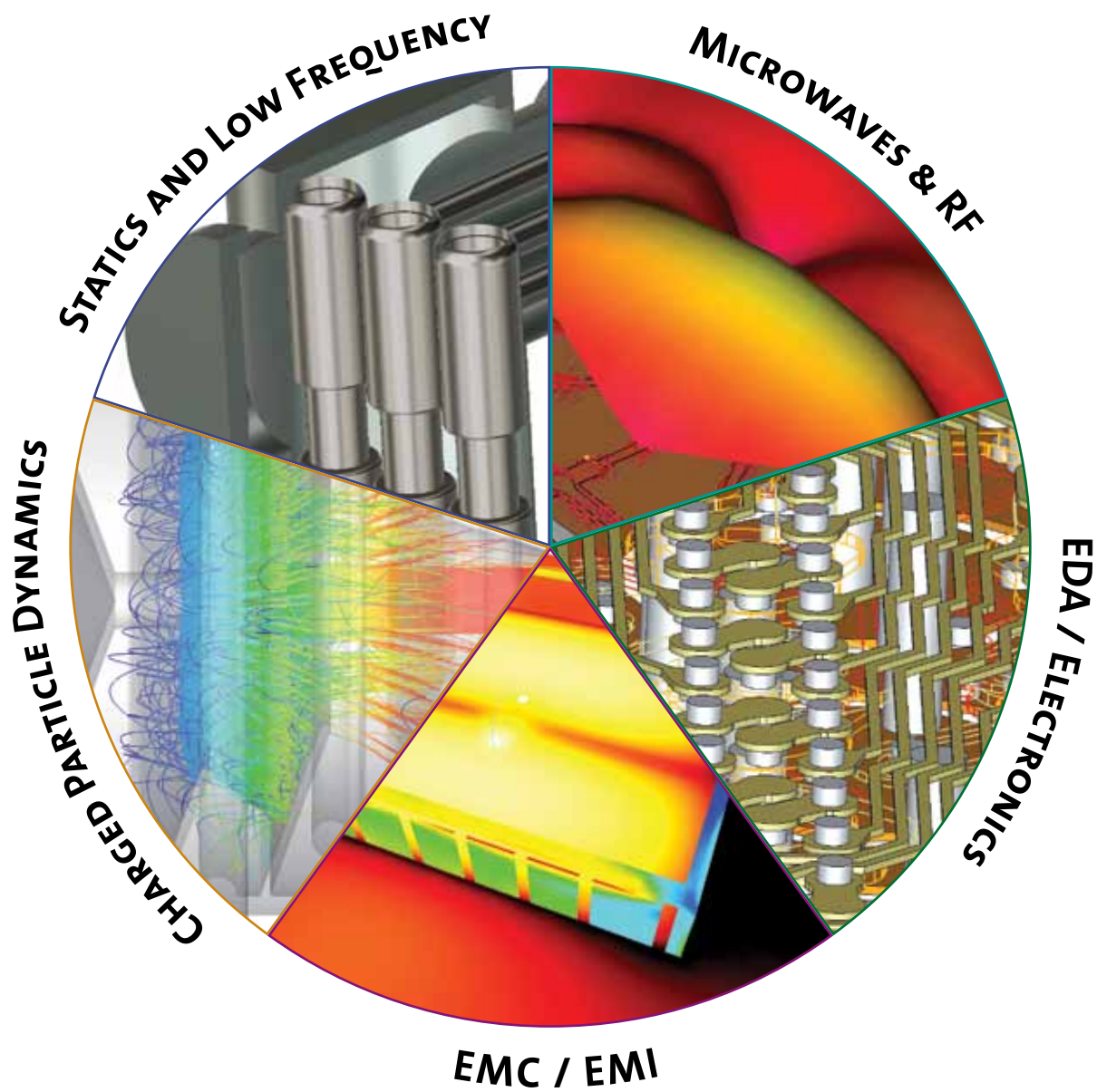



CST STUDIO SUITE

The integrated design environment gives access to the entire range of solver technology and facilitates circuit and multi-physics co-simulation.



CST MICROWAVE STUDIO (CST MWS): the leading edge tool for the fast and accurate simulation of high frequency devices. Application areas include Microwaves & RF, EDA/Electronics, and EMC/EMI.



CST EM STUDIO (CST EMS): for the design and analysis of static and low frequency EM applications such as motors, sensors, actuators, transformers, and shielding enclosures.



CST PARTICLE STUDIO (CST PS): a highly specialized product for the fully consistent simulation of free moving charged particles. Applications include electron guns, cathode ray tubes, magnetrons, and wake fields.



CST CABLE STUDIO (CST CS): for signal integrity and EMC/EMI analysis of cable harnesses.



CST PCB STUDIO (CST PCBS): for the simulation of signal and power integrity and EMC/EMI on printed circuit boards.



CST MPHYSICS STUDIO (CST MPS): for thermal and mechanical stress analysis.



CST DESIGN STUDIO (CST DS): a versatile tool that facilitates 3D EM/circuit co-simulation and synthesis.

Trademarks

CST, CST STUDIO SUITE, CST MICROWAVE STUDIO, CST EM STUDIO, CST PARTICLE STUDIO, CST CABLE STUDIO, CST PCB STUDIO, CST MPHYSICS STUDIO, CST MICROSTRIPES, CST DESIGN STUDIO, PERFECT BOUNDARY APPROXIMATION (PBA), and CST of AMERICA are trademarks or registered trademarks of CST in North America, the European Union, and other countries. Other brands and their products are trademarks or registered trademarks of their respective holders and should be noted as such.

CST STUDIO SUITE

CST STUDIO SUITE benefits from an integrated design environment which gives access to its entire range of solver technology. This was developed in response to the growing demand for coupled problems and co-simulation:

- EM/circuit co-simulation.
- Thermal analysis using all 3D electric loss results.
- Analysis of mechanical stress
- Magnetostatic analysis of current flow fields.
- Charged particle simulation with 3D static and eigenmode fields.
- Trace and cable currents for full 3D EMC/EMI analysis

CST MWS models can also be embedded in other RF/microwave circuit systems.

The intuitive and easy-to-use graphical user interface is common to all of the CST 3D simulators. Several projects can be opened simultaneously in a single front-end using the multiple document interface.

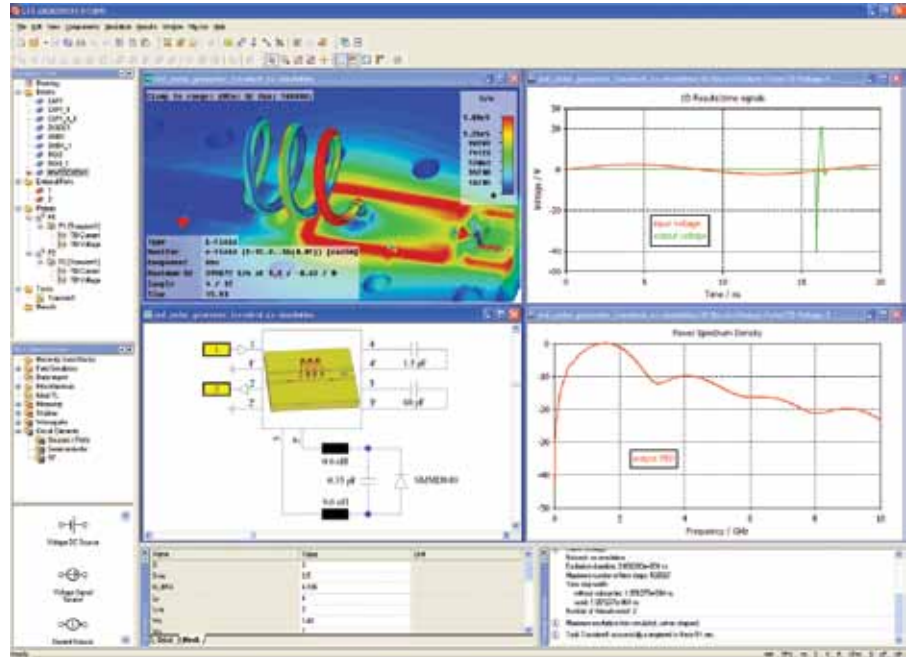

The true transient EM/circuit co-simulation of a sub-nanosecond pulse generator: a 60 MHz signal is converted into a sharp pulse by a strongly non-linear step-recovery diode (SRD).

The integrated optimizer operates within and between the solver modules. Projects can be controlled using the VBA macro language and COM/DCOM

implementation. Distributed computing and the job control center facilitate the management of projects and distribution of simulations on a network.

CST DS, CST STUDIO SUITE's schematic tool, can facilitate the co-simulation of multiple blocks (EM, circuit, 3rd party). For each CST MWS model, an associated CST DS schematic is created automatically. True transient 3D EM/circuit co-simulation provides a powerful means to include non-linear elements in 3D EM simulations to speed up multi-port EM/circuit co-simulation. Furthermore, a divide and conquer approach can be used in CST DS for the decomposition of large microwave components into smaller sub-components which can be handled with greater ease and speed.

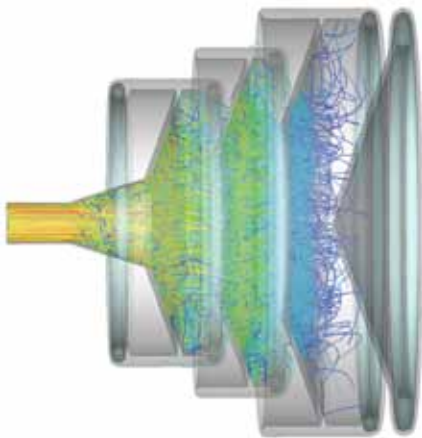

Depressed collector: electrons are decelerated by electrostatic fields and absorbed by the metal, secondary electron emission is considered. Particle trajectory (left) and resulting temperature distribution (right).

SIMULATION PERFORMANCE

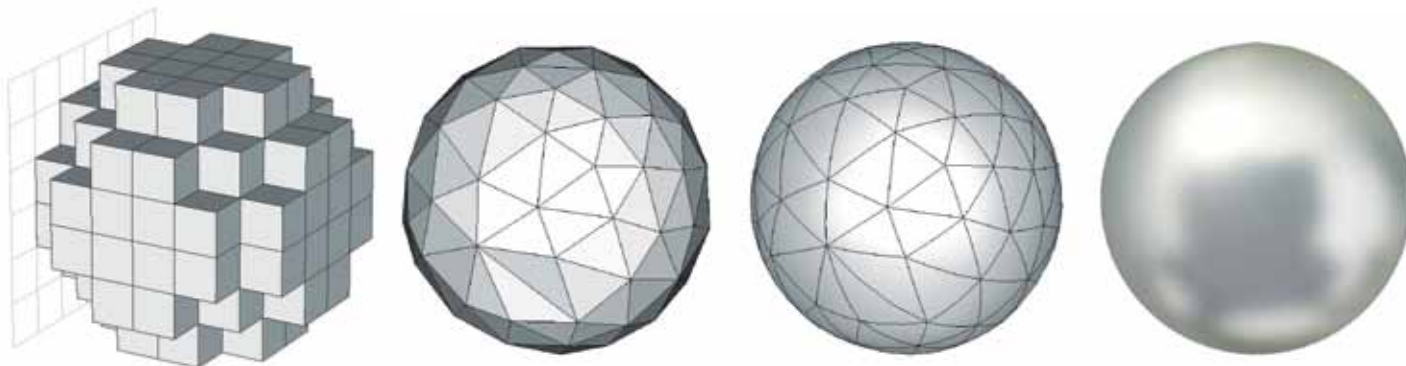

Various meshing strategies for a simple sphere: staircase, tetrahedral linear, tetrahedral curved, and CST's proprietary technology PBA.

Simulation performance can be expressed as the time required to arrive at an accurate numerical simulation result from the initial design idea. The quest to solve ever larger and more complex models demands continuously increased performance. CST products have consistently achieved excellent performance on various levels: design intent capture in the modeler, workflow integration, advanced numerical algorithms, high performance computing, and automated evaluation and optimization. These are the essential ingredients for fast and successful design.

PERFECT BOUNDARY APPROXIMATION

CST gained a major competitive advantage with the introduction of PERFECT BOUNDARY APPROXIMATION [PBA][®] technology into the Finite Integration Technique (FIT).

The standard FDTD staircase grid is pretty efficient for a large number of mesh cells, but it does have a major drawback when it comes to the geometrical approximation of arbitrarily shaped structures.

In a convergence study, the achieved accuracy of a staircase model improves slowly and unsteadily and takes a large number of iterations. The geometrical precision achieved thanks to PBA enables smooth broadband convergence with a minimum number of passes. Tetrahedral meshing has more or less the opposite strengths and weaknesses of staircase meshing. PBA combines the advantages of both standard approaches and offers a superior solution for most applications.

The introduction of arbitrary order curved elements in CST STUDIO SUITE 2011 represents a major step forward in tetrahedral meshing technology.

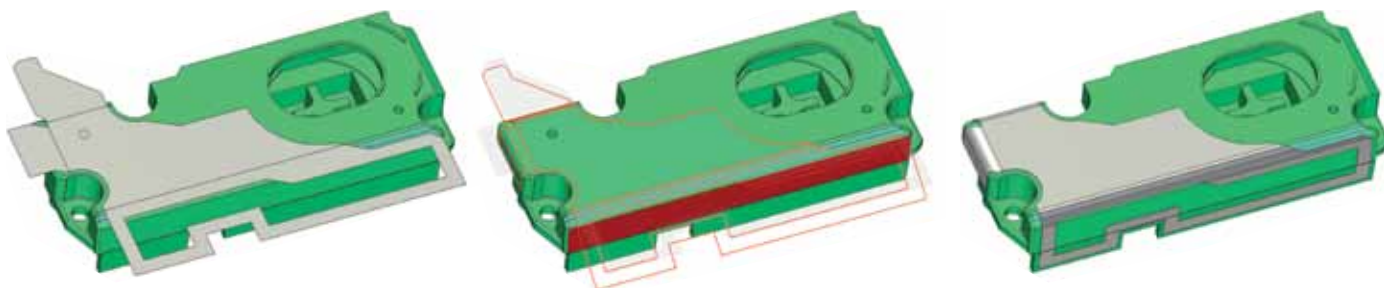

Advanced features such as "bending" can facilitate and speed-up the modeling process.

TRUE GEOMETRY ADAPTATION

Traditional mesh refinement algorithms of tetrahedral frequency domain solvers do not improve upon the initial faceted representation of the structure. CST's true geometry adaptation projects the refined mesh back onto the original model. In combination with arbitrary ordered of curved elements, unprecedented accuracy for tetrahedral meshes can be achieved.

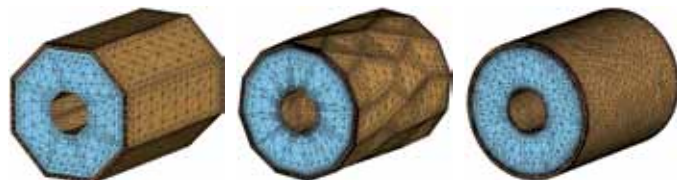

Coaxial waveguide after traditional mesh adaption approaches (left and middle) and true geometry adaption (right).

BROADBAND SIMULATION

Time domain simulation with CST MWS delivers a multitude of time and frequency domain results such as time signals and s-parameters, and farfields in the time and frequency domain. A transient simulation can provide results at many frequency points with an arbitrarily fine frequency resolution in just one simulation run.

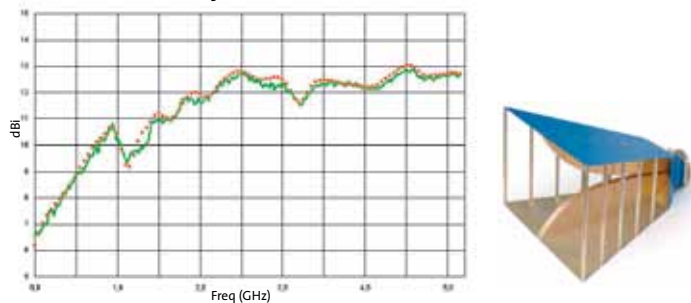

Excellent agreement between measured and simulated broadband gain of a Satimo dual-ridge horn antenna.

“The ERNI Ermet zeroXT connector is able to transmit differential signals up to a data rate of 10 Gbit/s [of a non-return zero code]. The complete design support, including the electromagnetic field analysis, the impedance calculation and the crosstalk analysis, was done using CST MICROWAVE STUDIO. Due to the accurate results, the connector could be manufactured, without a major re-design, in one pass.”

Dr. Thomas Gneiting, AdMOS

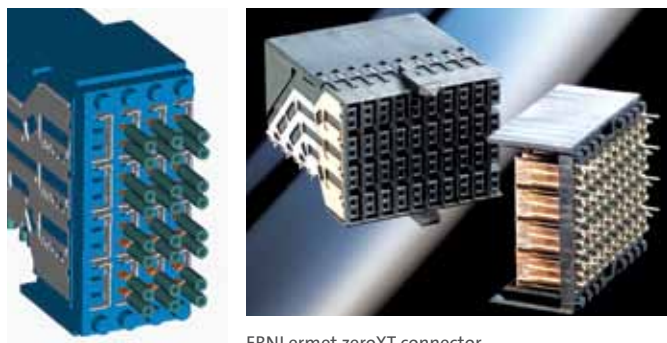

ERNI ermet zeroXT connector.

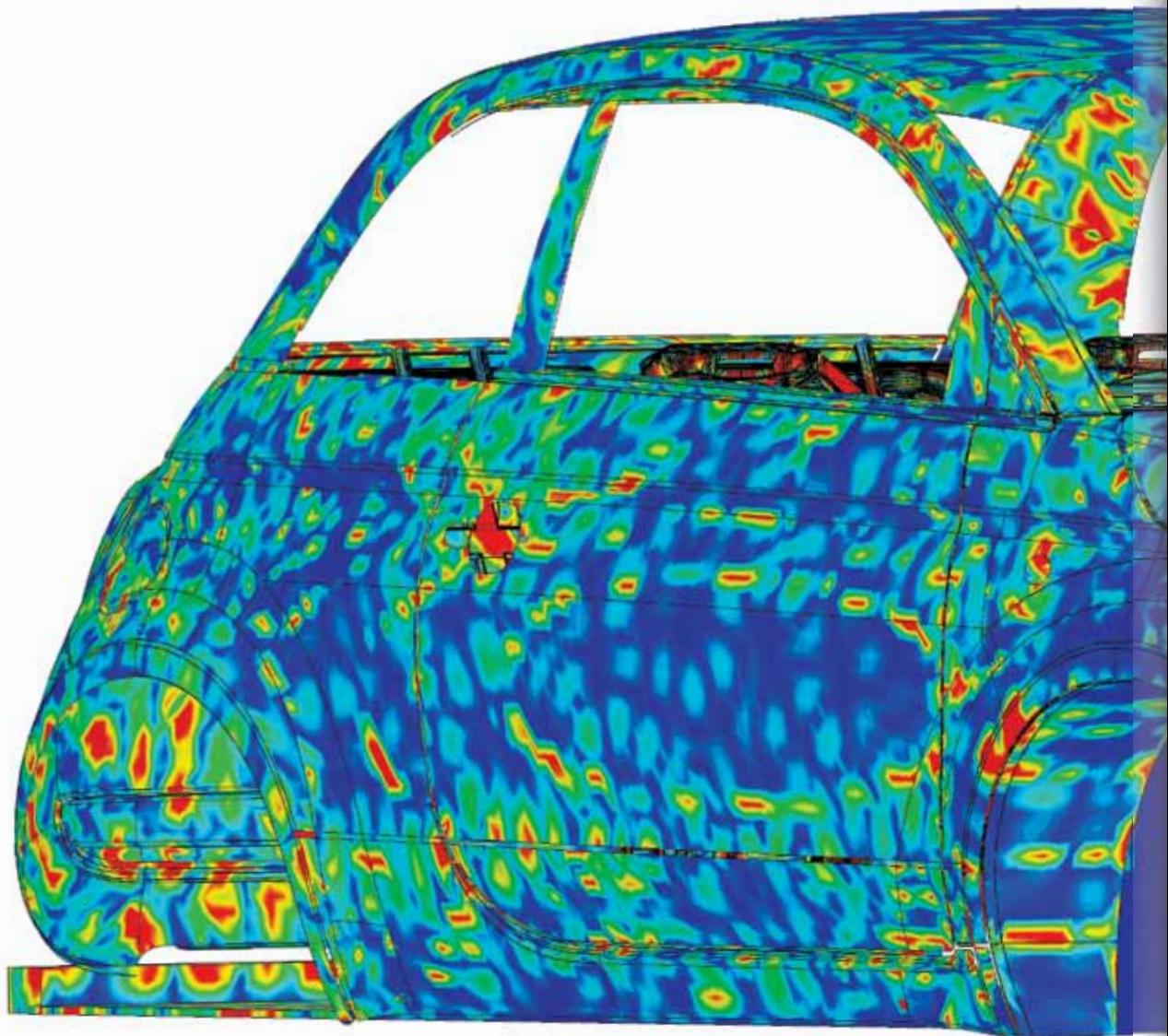

Surface currents excited by an in-vehicle antenna

THE RIGHT SOLVER FOR THE JOB

Simulation performance is strongly dependent on solver selection. The most important criteria are geometric complexity, resonant behavior, and electrical size. Choosing the optimal solver may dramatically decrease simulation time, but the weight of the criteria may not always be clear. The efficiency of the transient solver predestines it for detail rich packages, whereas frequency domain methods may excel at other electrically small applications. The Complete Technology approach of CST STUDIO SUITE enables you to choose comfortably between different solvers within one single user interface.

HANDLING DETAILS

Many practical problems have different levels of detail in different regions of the simulation model. CST employs various technologies to optimize simulation performance for these cases. Mixed order elements in the frequency domain solver, as well as subgridding schemes for the broadband transient solvers, have been implemented. Compact models can replace fine details such as vents and seams by macro models. EM field results can be made available in other solvers through broadband field sources.

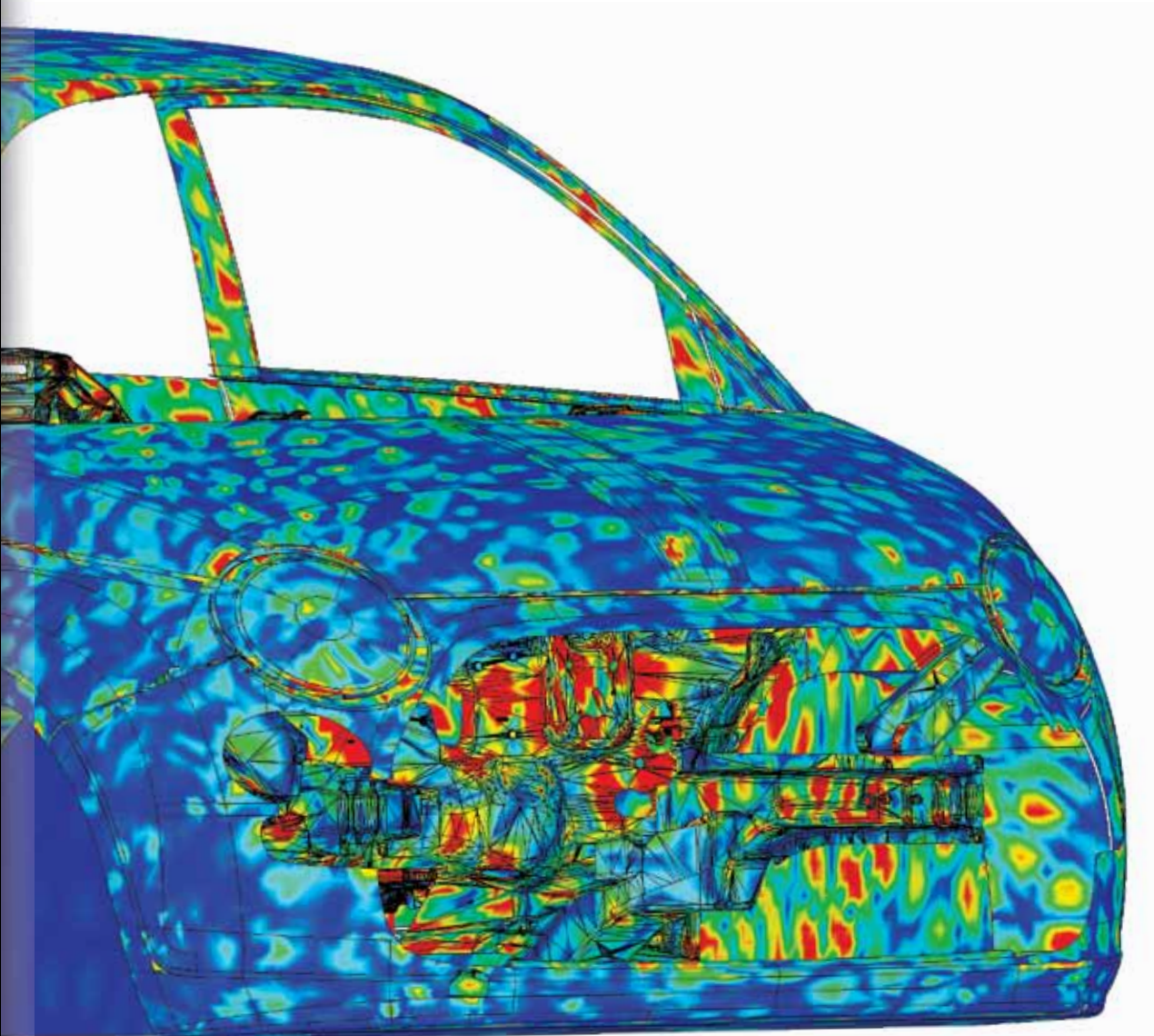

SENSITIVITY AND YIELD ANALYSIS

The sensitivity of a device's performance to parameter changes may be a crucial property of a design. CST MICROWAVE STUDIO allows you to evaluate the S-parameter dependencies on various model parameters on the basis of one single transient or frequency domain simulation. Since results for different model parameters can subsequently be derived without additional full wave simulations, yield analysis for complex three dimensional models becomes available at virtually no additional computational cost.

OPTIMIZATION

Finding the best solution is a task which is considerably eased by using effective optimization strategies. CST STUDIO SUITE features a number of automatic algorithms for local and global optimization. The models created by the sensitivity analysis can also be used for efficient optimization. The newly implemented Trust Region optimizer minimizes the number of 3D simulations required to find the optimal solution for a given set of goals.

DISTRIBUTED COMPUTING

In order to get your designs right quickly, you need automatic optimization and parameter studies. Wouldn't it be nice to go on to your next task while the simulation is performed in the background on another, dedicated machine? Or even better, run this job in parallel and cut down optimization time. CST's distributed computing offers you a cost effective means of doing just this.

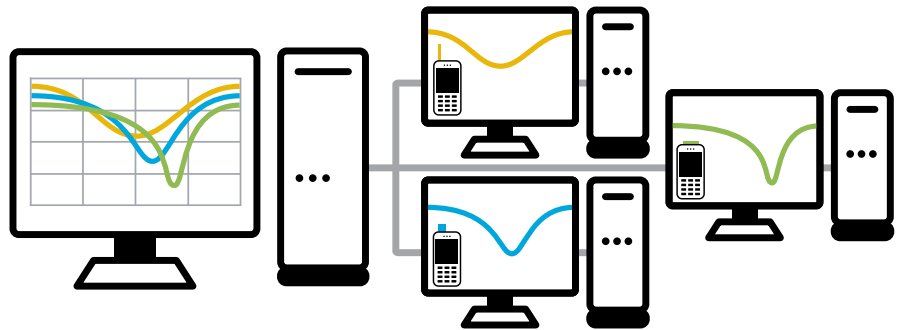

Increased performance through distributed computing.

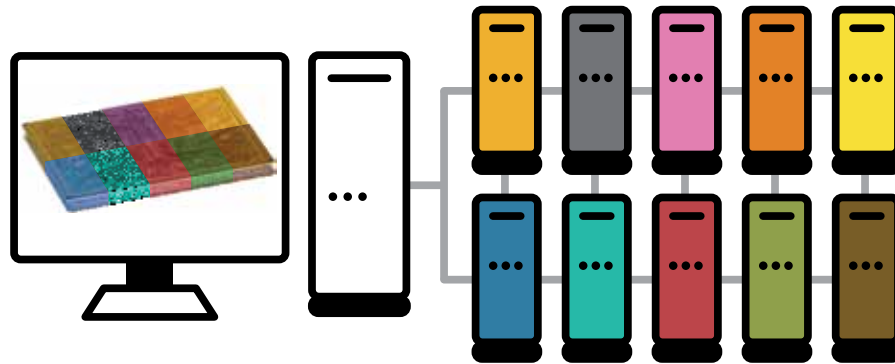

Domain decomposition of a complex package: MPI is used to distribute the various parts over a network of several computers.

CLUSTER COMPUTING

CST's parallelization based on the Message Passing Interface (MPI) enables the usage of computers in a network. It increases performance in two ways:

1. Reduction of simulation time through parallel use of CPUs on several computer systems.
2. Ability to simulate models previously too large to solve by using domain decomposition.

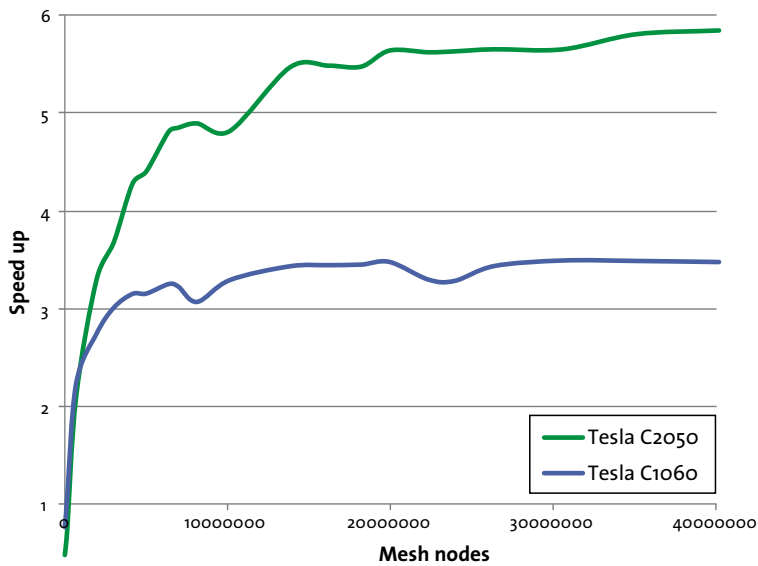

Speedup of solver loop for GPU computing of NVIDIA® Tesla™ C1060 and Tesla™ C2050 (codename Fermi) compared to 2x Intel® Xeon® E5520

MULTI-CPU AND GPU COMPUTING

Accurate conformal methods improve simulation performance by orders of magnitude compared to standard approaches. Additionally, efficient implementation on powerful hardware delivers a competitive edge.

CST and Intel are collaborating to provide optimal performance on the latest multicore hardware platforms for users of CST STUDIO SUITE technology.

Besides mainstream CPU development, graphics processing units (GPUs) enable low-cost, high performance computing. CST is at the forefront of development, employing this technology to speed up accurate simulation.

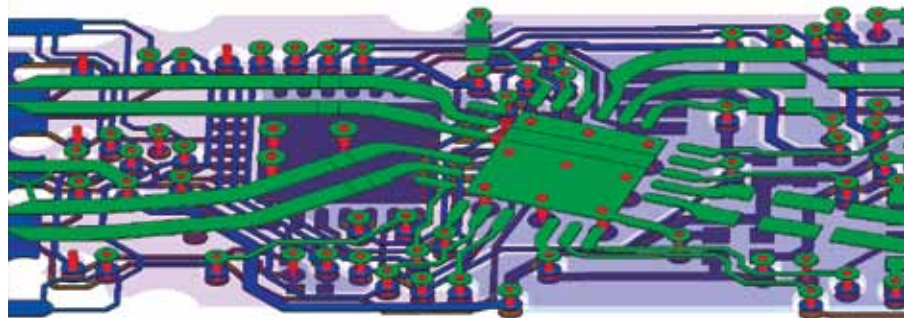

Signal Integrity simulation of a PCB: the board (right) and eye diagram of one signal trace (left).

CST SIMULATION ACCELERATION

CST offers a multitude of simulation acceleration options such as multi-CPU processing, GPU processing, cluster computing, and distributed computing. In order to help secure your investments as well as facilitate your choice of the most effective acceleration solution for a given simulation model, CST has introduced an acceleration token scheme. This enables greater versatility in accessing and combining simulation acceleration options. For example, one token can be used to increase the number of computers used in a cluster in one simulation run, and the next run, to distribute a parameter process over the network.

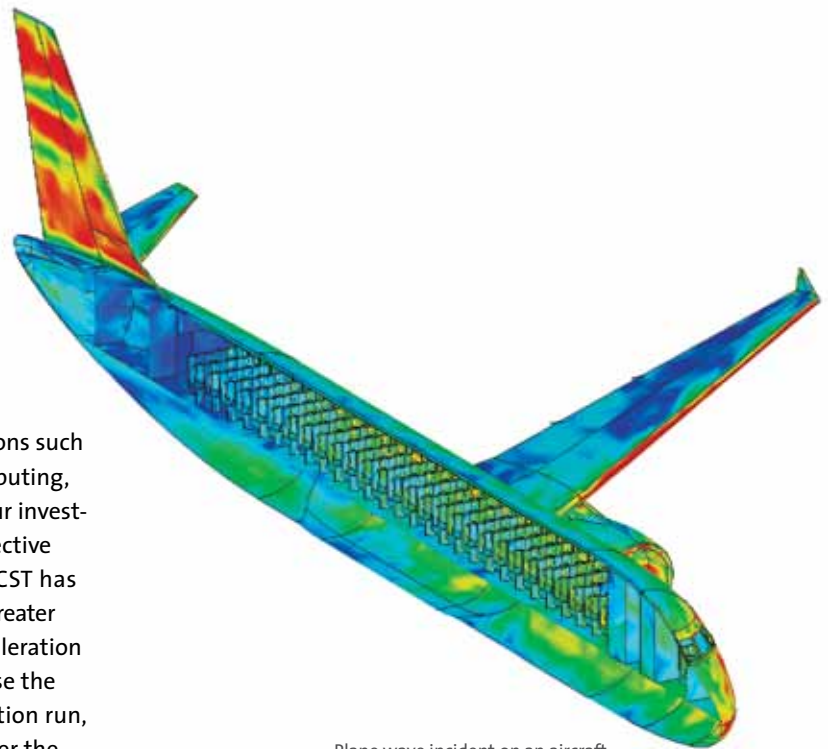

Plane wave incident on an aircraft

“Everything is going well with our use of CST, and your support is much appreciated. In fact, such prompt support is a major reason that WD will continue to utilize CST in the future (in addition to its technical advantages).”

William Huber,
Western Digital Corporation

DISTRIBUTED COMPUTING

Parameters

Ports

Frequency points

CLUSTER COMPUTING

MPI based
parallelization

HARDWARE IMPLEMENTATION

GPU computing
(CUDA)

Multi-CPU
computing

CST simulation acceleration options.

WORKFLOW INTEGRATION

USING THE BEST-IN-CLASS

CST consistently promotes the best-in-class approach. We specialize in developing 3D EM software and provide straightforward, easy-to-use links with other best-in-class vendors, connecting all available expertise. A wide range of import/export filters enable the easy exchange of geometrical data with CAD tools. Furthermore, imported structures can be modified, parameterized, and used for optimization and design studies.

Special interfaces to various EDA tools for signal integrity analysis and to RF circuit/system simulators for EM/circuit co-simulation enhance and unite the capabilities of different worlds. Moreover, the powerful VBA based and OLE compatible macro language allows direct communication with programs like MATLAB® or MS Excel®.

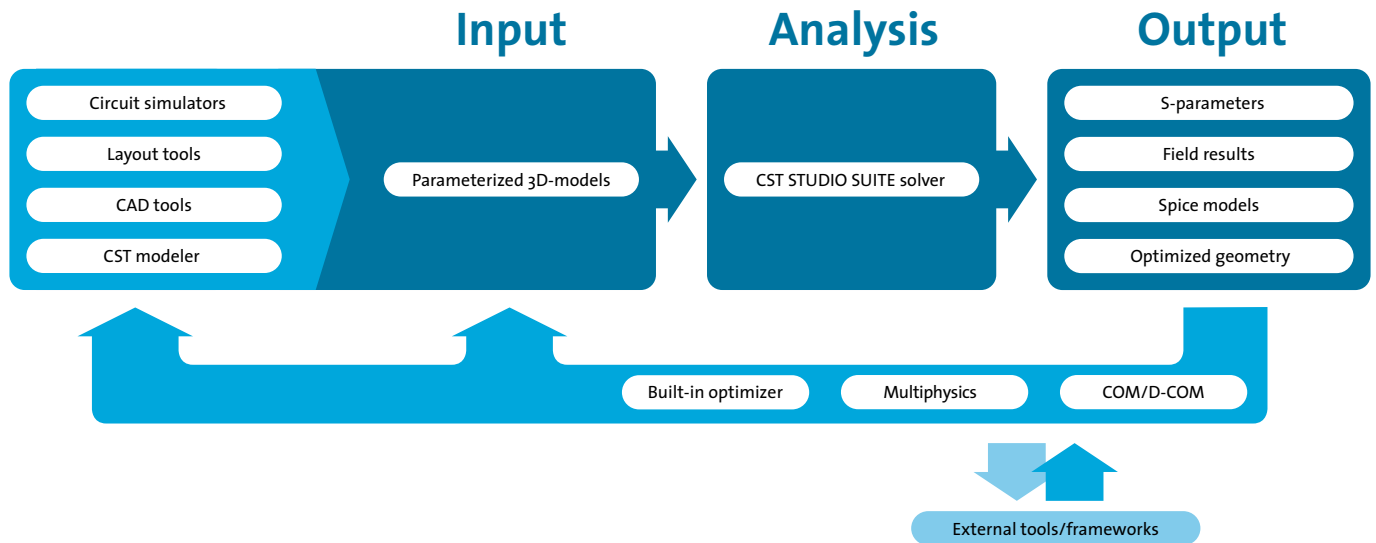

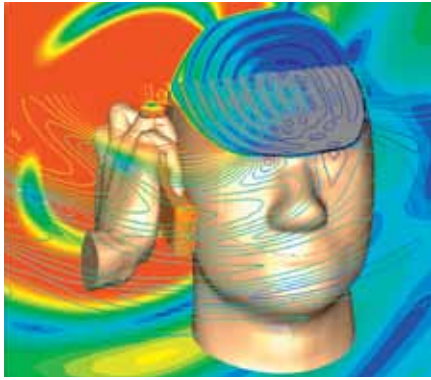

EM field distribution of a Sony Ericsson mobile phone at 1.8 GHz for SAR analysis: the mobile phone's CAD data was imported using the STEP interface and combined with a hand and SAM model.

The import and export of structural information is fundamental to embedding a OBJ simulator in a design flow. CST STUDIO SUITE filter options include: SAT, STL, IGES, STEP, Nastran, VDA-FS, Autodesk Inventor®, Pro/ENGINEER®, CATIA® v4 and v5, DXF™, GDSII, Multilayer Gerber, ODB++, Altium® P-CAD®, Altium Protel 99SE, Cadence® Allegro®, Cadence SPECCTRA®, Mentor Graphics® Expedition™, Mentor Graphics Board Station®, Mentor Graphics HyperLynx®, Mentor Graphics PADS®, Zuken CR5000, Zuken Visula, Agilent ADS layouts, AWR Microwave Office® layouts, Sonnet® models, biological voxel data.

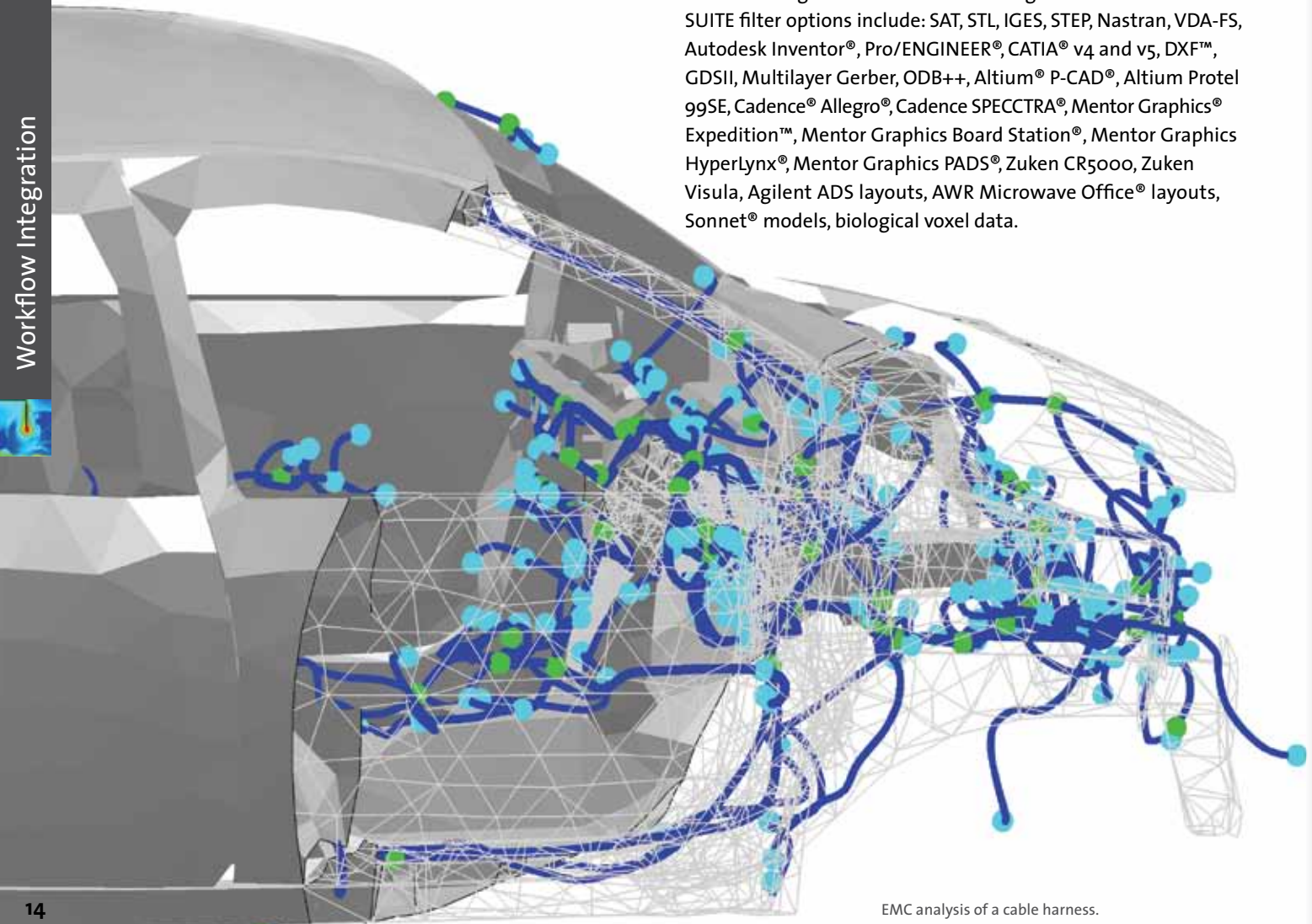

EMC analysis of a cable harness.

IMPORT QUALITY

Import options are available in the majority of simulation tools nowadays, but their effectiveness is often impaired by seemingly insignificant details.

There is nothing more frustrating than successfully importing 98% of a structure, as the missing 2% may make it impossible to continue and it could cost days to fix the problem.

Imports from EDA tools are particularly prone to small gaps and edges which unnecessarily complicate the simulation model. CST MWS contains a sophisticated cleaning procedure as well as automatic healing; these features, combined with the robust mesher, enable effective simulation, even for quite corrupt CAD data.

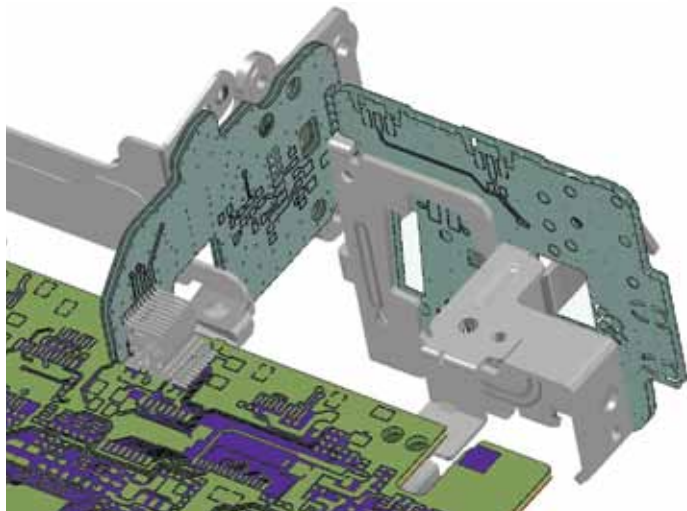

Detail of a camcorder: the complete device was modeled, simulated and subsequently modified to comply with FCC Class-B.

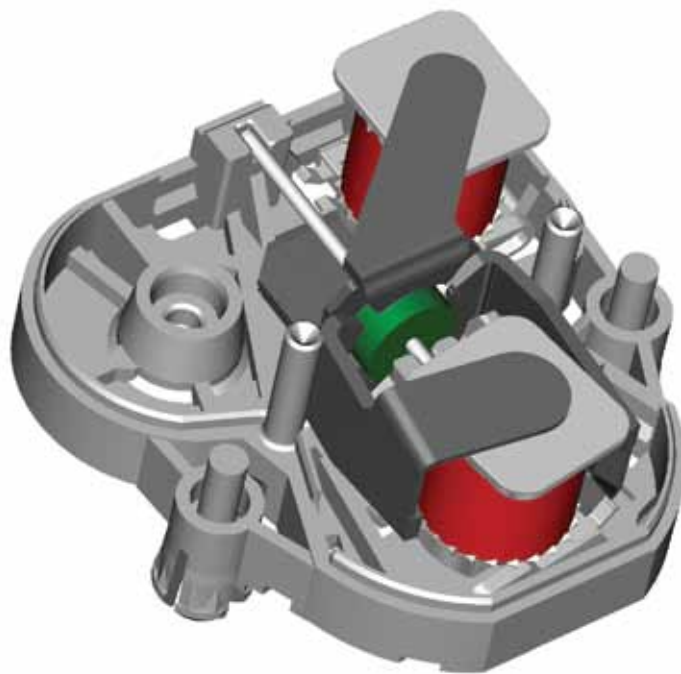

Gauge for a speedometer driven by a stepping motor imported through the IGES interface.

“CST specializes in passive 3D EM field simulation, and through partnerships with best-in-class active simulation tools, has made true co-simulation and co-optimization an everyday task. CST MICROWAVE STUDIO contains a powerful and easy to use solid modeler, and its powerful import filters enable the successful import and parameterization of complex geometrical data.”

3D EM Application Team,
Infineon Technologies AG

COMPLETE TECHNOLOGY

Just a decade ago, experts argued which technology would dominate the 3D EM simulation market: time or frequency domain? Time domain was known for its ability to solve problems with a large number of mesh cells, whereas frequency domain – using tetrahedral instead of rectangular gridding – often offered better geometry approximation. Both methods have evolved a great deal since then; CST’s achievement in overcoming the disadvantages associated with the time domain’s staircase approximation has proved especially important. But it’s still true that no one method is perfect for every application. With this in mind, CST has developed frequency domain technology which complements the time domain as a general purpose solver. With version 2010, CST MICROSTRIPES has joined CST STUDIO SUITE. Its TLM method complements the current range of solvers, particularly with respect to EMC/EMI applications. Moreover, in response to the demand for simulating ever larger structures CST STUDIO SUITE includes an integral equation solver (with MLFMM), and an asymptotic solver.

WHY IS IT IMPORTANT TO HAVE A COMPLETE SOLUTION?

CST software allows you to switch from one solver to another easily, without changing the model and parametric settings. So you can choose the most appropriate method for each problem, thus minimizing your simulation run time. You only need a test password and you can try out any feature or solver. A nice side effect of this is that adding an additional solver is far more economical than buying a whole new package.

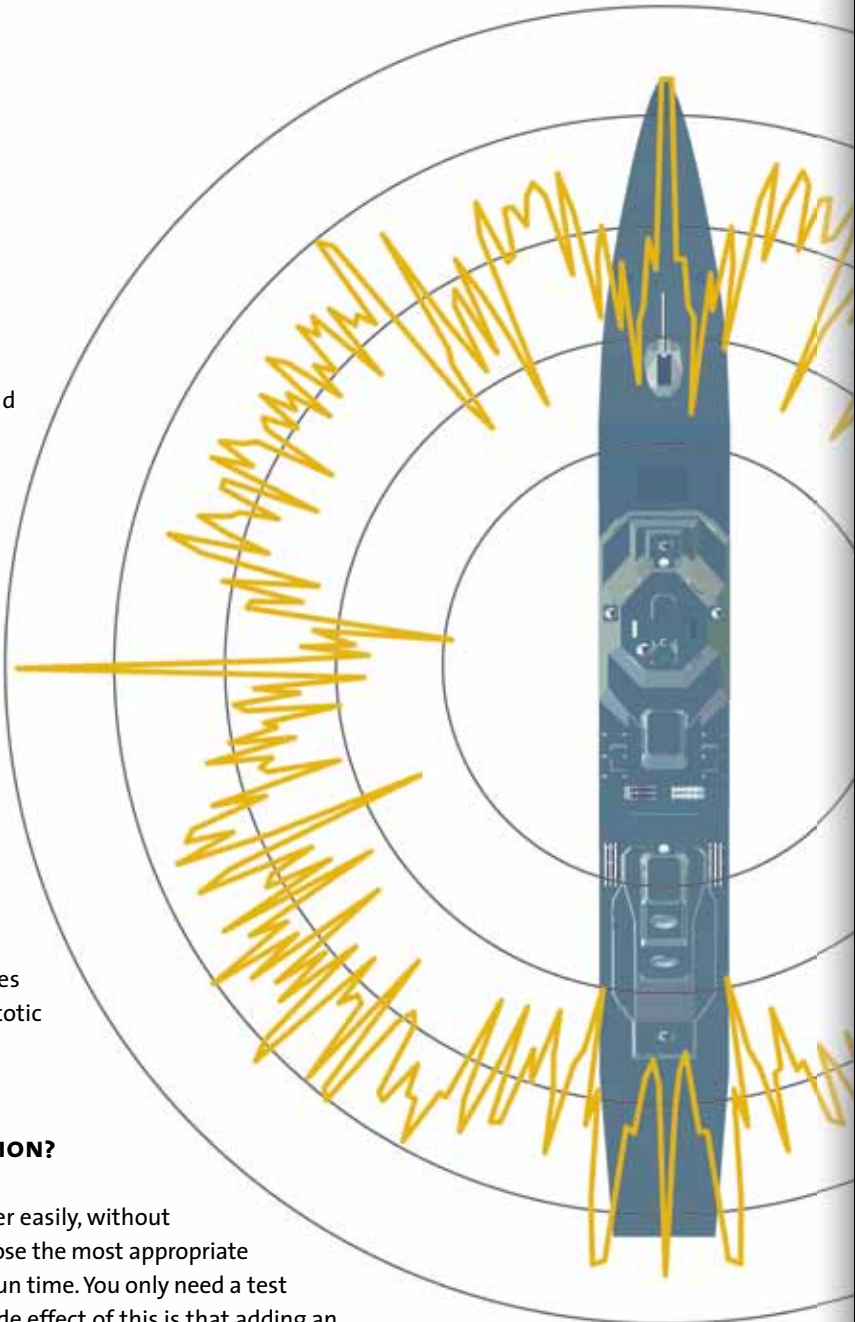

RCS of a ship at 16.8 GHz



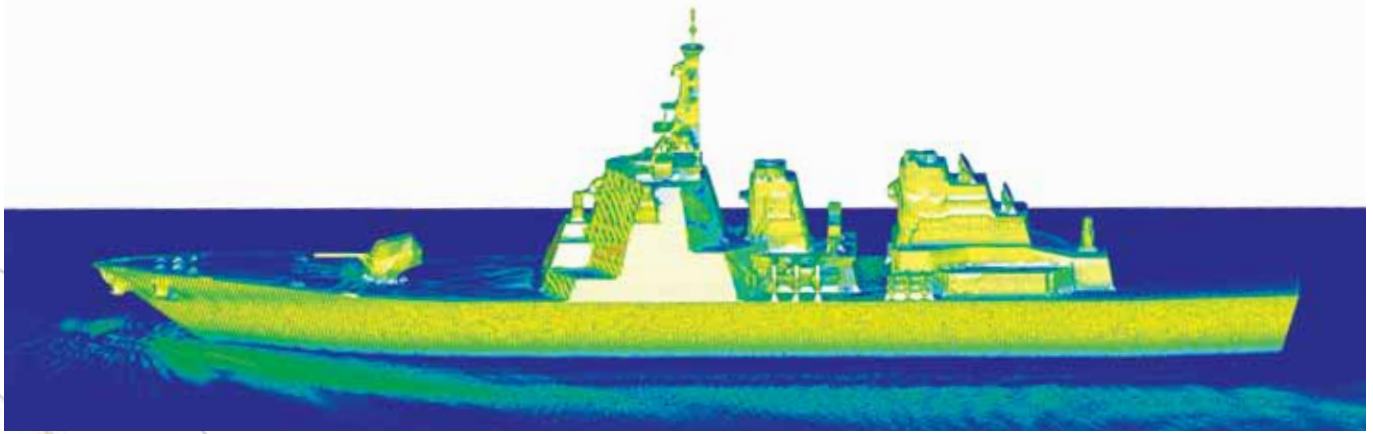

Current distribution on the metallic surface of a 155 m long ship excited by a plane wave of 400 MHz: the relative permittivity (ϵ_1) and conductivity (0.01 S/m) of salt water are considered in the simulation.

CONFIDENCE THROUGH CROSS VERIFICATION

Sometimes simulation and measurements just don't agree, but why? If the measurement was made by another work group they may quickly come to the conclusion that the simulation must be wrong. By running a simulation with both time and frequency domain solvers you can greatly increase confidence in your results. Reaching agreement with two different numerical methods proves that the deviation must have been caused by another factor, such as wrong material values or measurement failure.

TRUE TRANSIENT EM/CIRCUIT CO-SIMULATION

A transient 3D EM/circuit co-simulation continuously exchanges currents and voltages at the ports between the CST MWS EM simulation and the circuit simulation in CST DS, while the signal propagates through the model. There are two major advantages to transient compared to standard EM/circuit co-simulation:

- The time consuming derivation of the 3D structure's full S-matrix is no longer required since the circuit elements are placed directly into the electromagnetic field simulation. This can lead to tremendous simulation speed-ups, especially for PCBs with many ports and lumped elements.
- Transient EM/circuit co-simulation also calculates the transient electromagnetic fields that result from the interaction with non-linear elements such as diodes. The broadband nature of the transient simulation means that many harmonics are automatically taken into account.

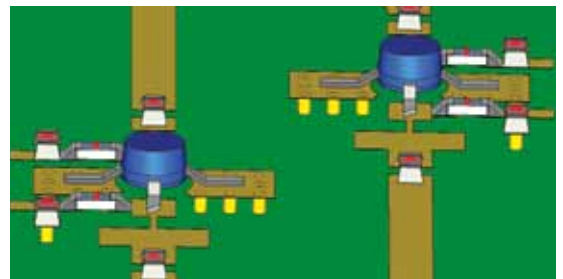

UWB balanced amplifier for 3-5 GHz analyzed using true transient circuit/EM co-simulation.



Imported PCB for power integrity analysis.

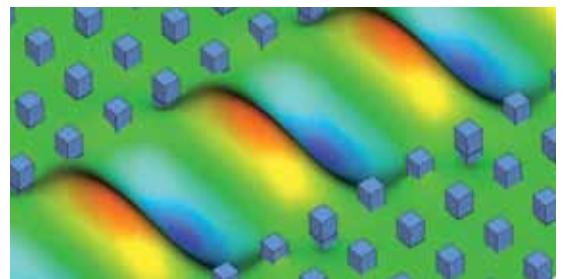

Line defect waveguide in a photonic crystal.

MULTI-PHYSICS ANALYSIS

Electromagnetic design is undoubtedly the main goal of most CST STUDIO SUITE users. However the fields create secondary effects. Metallic or dielectric losses could heat up and even damage the structure. Resulting forces could mechanically deform a device and change the electromagnetic behaviour, for example, detune filters. CST MPHYSICS STUDIO contains a number of solvers for the analysis of stationary and transient thermal effects (including a bio-heat description for biological tissues) as well as mechanical stress. The solver modules are tightly integrated for a seamless multi-physics workflow.

“CST MICROWAVE STUDIO is our daily work-horse for fast and accurate EM simulation of passive microwave components. It lays a solid foundation from which Spinner provides high performance RF technology worldwide.”

Dr. Martin Lorenz, Spinner GmbH

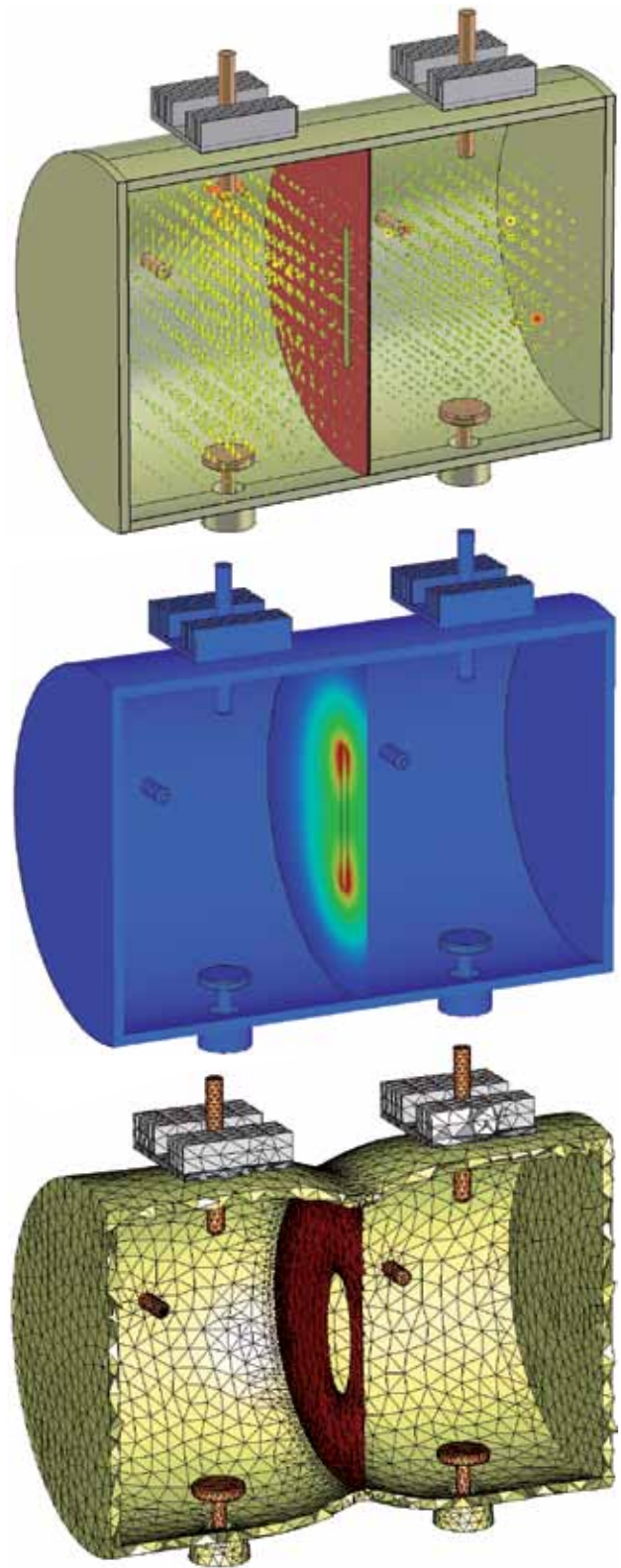

Multi-physics analysis of a cavity filter (courtesy of Spinner GmbH): the electric field, the temperature distribution and the mechanical deformation, exaggerated plot.

CST – COMPUTER SIMULATION TECHNOLOGY



Founded in 1992, CST offers the market's widest range of 3D electromagnetic field simulation tools.

CST's ground breaking "complete technology" complements its market and technology leading time domain solver, thus offering unparalleled accuracy and versatility for all applications.

Customers operate in industries as diverse as Telecommunications, Defense, Automotive, Electronics, and Medical Equipment, and include market leaders such as IBM, Intel, Mitsubishi, Samsung, and Siemens.

Today CST employs more than 180 sales, development, and support personnel, and enjoys a market share of over 30 % in high frequency 3D EM simulation.

FOUNDATION OF CST'S SUCCESS

CST's success is based on the implementation of leading edge technology in a user-friendly interface.

With the introduction of the proprietary PERFECT BOUNDARY APPROXIMATION (PBA) in 1998 with the first version of CST MICROWAVE STUDIO (CST MWS), CST's flagship product, CST established a profound technical advantage.

CST has built on this success, encouraging innovation and investing in product development. The resulting expansion in solver technology has created CST's "complete technology" approach to simulation. This enables users to select the most appropriate method for their application and can offer additional security through cross verification.

CST provides timely local support through its highly qualified technical support forces. Together with its committed distributors and representatives, CST supports its EM products in over 30 countries.



© CST 2010 | CST – Computer Simulation Technology | info@cst.com | www.cst.com

