

Torque Analyzer & Test Measurement

CATALOG

Jyoti Electronics
Authorized Rep For Country
Mobile No. :- +91 9426511222
Tel.Fax:07926857715 / 17
Jyoti@jyotimicrosystems.com
info@jvoti.net.in
www.jvotielectronics.com
Ahmedabad



Table of Contents

- 1.1 Certification Explanation
- 1.2 EZ-TorQ (Torque Analyzers)

- 1.3 TorqueLab LTT-Series (Torque, Angle & Force Analyzers)
- 1.4 TorqueMate PTT-Series (Torque, Angle & Force Analyzers)

- 1.5 Wizard Plus (Torque & Force Analyzer)
- 1.6 Dial Analyzer (Hand Tool Torque Analyzers)

- 1.7 LPX (Low Profile Torque Reaction Transducers)
- 1.8 BMX (Torque Reaction Transducers)

- 1.9 RTSX (Rotary Torque Transducers)
- 1.10 RTSX-A (Rotary Torque & Angle Transducers)

- 1.11 BLRTSX-A (Brushless Rotary Torque & Angle Transducers)
- 1.12 BLRTSX (Brushless Rotary Torque Transducers)

- 1.13 BLRTSX-R/RA (Brushless Rotary Torque & Angle Shaft Transducers)
- 1.14 BLRTSX-RAU (Brushless Rotary Torque & Angle with Mounting Base Transducers)

- 1.15 SDX & ETX (Torque Screwdriver & Wrench Transducers)
- 1.16 SMX (Torque Socket Transducers)

- 1.17 Loading Bench (Calibrating Wrenches)
- 1.18 Calibration Test Equipment (For Torque Analyzers & Transducers)

- 1.19 Calibration Stands & Mounting Brackets
- 1.20 Accessories (Hex Step Adapters & Run Down Adapters)

- 1.21 Bar Code Reader & Multiplexer
- 1.22 TorqueMate Digital Wrench

Certification Explanation

CUSTOMER COMMITMENT

Mountz takes the subject of quality seriously – from intricate manufacturing processes to comprehensive laboratory testing of equipment – we strive to meet your requirements every step of the way. Mountz torque equipment is used to assess, control, and improve the quality of our customer's products. The value added by providing premier quality tools is enhanced product reliability and increased customer satisfaction for our business and yours.

QUALITY STANDARDS

To meet customer requirements, we begin with compliance to stringent, world-class quality standards.

- Mountz is an ISO 9001 and ISO 17025 registered company.
- Design and testing of all hand tools conforms to requirements of ISO 6789, as specified.
- Laboratory operations and calibrations meet the requirements of ANSI/NCSL Z540-1.

CALIBRATION SERVICES

Mountz offers calibration services for all of our own equipment, as well as models from most other manufacturers. The certificate supplied with each calibration has been revised to include new content and an easy-to-read modular format. All calibrations are performed using NIST-Traceable standards, and meet the requirements of ANSI/NCSL Z540.

SUPPLIER

Identifies name and location of laboratory issuing certificate as well as certificate number.

EQUIPMENT TESTED

Easy identification of tool type, maximum capacity, serial number, and accuracy. Also indicates arrival condition of tool, service performed, calibration date, interval, and due date.

STANDARDS USED

Identifies procedure and equipment used to perform the calibration, as well as test accuracy ratio.

MEASUREMENT DATA

Gives the nominal point(s) at which the tool was tested, tolerances, actual measurement before adjustment and after, environmental conditions during test, and other associated data.

CERTIFICATION

Section for approval of certificate content by authorized signatories. Also includes statement of compliance with relevant calibration standards and NIST-Traceability.

EXTERNAL TRANSDUCERS

In the case of external transducer and display systems, it is preferable and sometimes required that all parts of a system be calibrated together. When purchasing external transducers, the Certificate of Calibration can only be supplied where transducers are purchased and calibrated together with a display monitor as a complete measuring system. Otherwise, only a certificate indicating transducer performance to specification is supplied, and calibration of the transducer to a display unit is still required for proper operation.

External transducers submitted to the Laboratory for "after-sale" calibration service without a display unit, will be calibrated using an equivalent calibrated display held in the laboratory whenever possible. Otherwise, the customer will be contacted to deliver their display unit when required to complete the calibration process.

CALIBRATION INTERVALS

In order to maintain accuracy, it is crucial that torque control and measuring equipment be calibrated regularly. We recommend general six (6) month calibration intervals. However, it is the user's organization that must determine suitable interval frequencies commensurate with their needs based upon many factors such as history of equipment performance, application, degree of usage, and management objectives.



CERTIFICATION

All Mountz analyzers and transducers are supplied with a NIST-Traceable Certification of Calibration.



CERTIFICATE OF CALIBRATION

This symbol identifies the products that are supplied with NIST-Traceable Certification of Calibration.

m mountz		Calibration Certificate		MOUNTZ ALABAMA 1000 UNDERWOOD RD MOLLY, AL 35009 205-943-4125 www.mountz.com		
Certificate No. 72462						
Calibration Performed For: CDM Technology 2872 Peck Drive Dusett Creek, AZ 85242 Work Order Number: 3023770						
Description: MH-MTBN135 TORQUE WRENCH PRESET GAM-OVER						
Mountz Cal ID:	27750	Cal Date:	1/8/2008			
Serial Number:	SFF030158	Cal Interval:	6 MONTHS			
Model Number:	MTBN135	Cal Due Date:	7/8/2008			
Range:	20-135	Arrival Condition:	PURCHASED NEW			
Unit of Measure:	N.M.	Service Performed:	CAL TO MFG SPEC			
Accuracy:	5% OF SETTING	Temp / RH%:	70 F / 40			
Procedure:	3M-1-9-001	Calibration Result:	PASS			
Calibration Status:		Test Rate:	+4.00 / 1			
Measurement Data:						
Seq.	Description	Nominal	Tolerance -	Tolerance +	As Found	As Left
1	Power Reading 1	50.00	±0.00	±0.00	50.00	50.00
2	Power Reading 2	50.00	±0.00	±0.00	50.00	50.00
3	Power Reading 3	50.00	±0.00	±0.00	50.00	50.00
4	Power Reading 4	50.00	±0.00	±0.00	50.00	50.00
Standards Used:						
Overhaul:	SWATCH TORQUE TRANSDUCER FIXED	LD	Range	Units	Accuracy	Cal Due
			1000	IN - LB	±0.5%	2/25/2008
Work Performed By:		Authorized Signature:				
Steve Hands		James Bassett		GP MANAGER		
MOLLY, AL		GP MANAGER				
Page 1 of 1						

EZ-TorQ

Torque Analyzer

Torque
Analyzers



KEY FEATURES

Accuracy \pm 0.5% of reading from 20% to 100% of full scale.
Accuracy \pm 1% of reading from 10% to 20% of full scale.

Recommended for small hand tools and non-impacting power tools.

Features a built-in transducer and graphic display.

Selection of two operating modes: Track and Peak.

Four units of torque measurement available:
lbf.in, cN.m, N.m, kgf.cm.

Switchable 110V and 220V.

Four-digit display.

Torque Analyzer operational in English, Spanish, French, German, Italian, and Chinese.

Selectable filters to eliminate unwanted "noise":
500Hz, 1000Hz, 1500Hz, 3000Hz.

RS-232 interface to download readings in "real time".

"Flash" memory allows upgrades to be done by the user or via the Internet.

Includes three PC Windows based software programs:
EZ Terminal - for updating firmware, selecting torque direction and changing languages
EZ Calibration - for multipoint calibrations
Data Acquisition - collecting and analyzing data with Microsoft Excel®

Includes a Spring Run Down Adapter.

Includes a Case, RS-232 cable, Universal Charger, and 1/4" Female/Hex Square Drive Adapter.

Two methods of calibration: a single point calibration (using a manual pot adjustment), and a multipoint calibration using EZ Calibration software.

Dimensions: (L x W x H) 7 1/4" x 4 1/3" x 2"



NOTE!

Since a tester cannot always duplicate actual joint characteristics, the torque reading displayed on the EZ-TorQ may vary from the actual torque that a tool will apply to a joint. A run down adapter that simulates a variety of different joint characteristics is provided with the EZ-TorQ. When critical assemblies are involved, the torque output of the power tool being used should be verified on the actual assembly using a calibrated measuring torque tool.



CERTIFIED

Supplied with NIST-Traceable Certification of Calibration

RoHS CE

Torque Ranges

Model	Item #	lbf.in	cN.m	kgf.cm	Drive Size	Weight
EZ-TorQ 10i	070500	1 - 10	11.3 - 113	1.2 - 11.5	17mm Female/Hex*	4.5 lbs.
EZ-TorQ 50i	070505	5 - 50	56.5 - 565	5.8 - 57.6	17mm Female/Hex*	4.5 lbs.
EZ-TorQ 100i	070510	10 - 100	113 - 1130	11.5 - 115	17mm Female/Hex*	4.5 lbs.
EZ-TorQ 150i	070515	15 - 150	169.5 - 1695	17.3 - 173	17mm Female/Hex*	4.5 lbs.

* This unit includes a 1/4" Female/Hex Square Drive Adapter that slides into the socket. Also, a Spring Run Down Adapter for dynamic power tools.



ACCESSORIES

SCREW RUN DOWN ADAPTERS

Item #	Model	American	Metric	Quantity
600728-1*	RDA	2 - 56	M2x.4	5
600728-2*	RDA	4 - 40	M3x.5	5
600728-3*	RDA	6 - 32	M4x.7	5
600728-4*	RDA	8 - 32	M5x.8	5
600734-18*	RDA	5/16 - 18	-	5
600734-20*	RDA	1/4 - 20	-	5

* Hardware Kit # 1 for these RDA units (includes Washer and Screws), Item # 061237.

See EZ-TorQ manual for a list of items that are included in the Hardware Kit.



SPRING RUN DOWN ADAPTERS

Provides consistent and reliable torque readings for use with power driven torque control tools.

See Page 01.20



CALIBRATION TEST EQUIPMENT

Calibrated Dead Weight and length are the official means by which Analyzers are traced to NIST, ISO etc.

See Page 01.18



ACCESSORIES

Item #	Description
770055	Charger
708003	Battery Pack
14-501830	Brush Cap
773855	RS-232 Cable
600727	1/4" Female/Hex Square Drive Adapter (17mm F/Hex)
600729	Case (Pictured Above)

etorque.com

ISO 9001 and ISO 17025 Company

EZ-TorQ
01.2

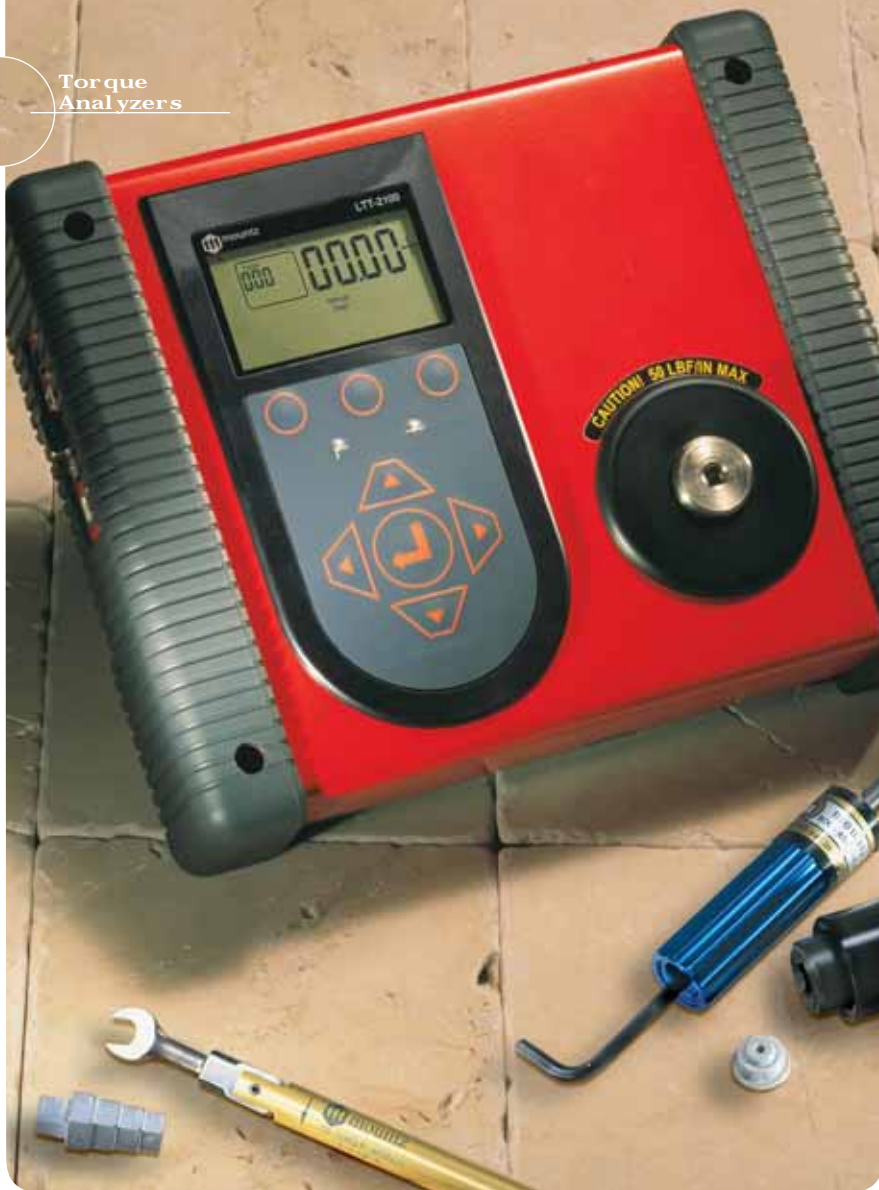

TorqueLab®

LTT Series

Torque, Angle & Force Analyzer with ARCII Technology

KEY FEATURES

- Accuracy \pm 0.5% of reading from 20% to 100% of full scale.
- Accuracy \pm 1% of reading from 10% to 20% of full scale.
- Recommended for all hand screwdrivers, wrenches, or power tools.
- Features a built-in transducer and can connect to an external transducer.
- Provides "EZ-Plug & Play" with Mountz Transducers, Features "ARCII" technology, an instant auto-recognition system of the transducer connected to the LTT.
- Selection of six operation modes: Track, Peak, First Peak, Audit, Spindle Audit, and Torque + Angle
- Seven units of torque measurements: ozf.in, lbf.in, lbf.ft, cN.m, N.m, kgf.m, kgf.cm
- Two units of force measurement: lbf and kN
- Features built-in Tool Tests operation.
- Includes three PC Windows based software programs:
 - Mountz Torque Meter Interface Program** for sensor calibrations, meter calibration and tool tests.
 - Torque Meter Bootloader** for updating the LTT operating systems.
 - Excel Add-In** for Real-Time data collection into an Excel spreadsheet. It provides statistics calculations.

"Flash" memory allows upgrades to be done by the user in the field & internet through the USB port.

Five low-pass filters: 3000, 2000, 1500, 500, and 200Hz

Six-digit display and easy to read menu structure.

Real Time Clock for time stamping of readings.

USB interface to download readings to PC.

High Capacity Li-ion Batteries for long life (30 hours with standard transducers and 16 hours with brushless rotary).

Can connect to most mv/v transducers and can store calibration data for up to 50 non-smart torque sensors.

The 5VDC capability allows unit to be used with a Brushless Rotary Transducer for testing pulse tools and high RPM tools.

Torque and Angle data is displayed simultaneously when used with Torque and Angle transducers, up to 8000 RPM for angle measurement.

Stores a total of 5000 data points.

Real time graph of torque vs. time using associated PC Windows software.

Features Go / No Go LEDs that illuminate when high or low setting is achieved.

Model	Item #	Torque Ranges			Drive Size	Wt.
		American	S.I.	Metric		
LTT10i	068400	1 - 10 lbf.in	11.3 - 113 cN.m	1.2 - 11.5 kgf.cm	1/4" F/Sq	8 lbs.
LTT25i	068401	2.5 - 25 lbf.in	28.25 - 282.5 cN.m	2.9 - 28.8 kgf.cm	1/4" F/Sq	8 lbs.
LTT50i	068402	5 - 50 lbf.in	56.5 - 565 cN.m	5.8 - 57.6 kgf.cm	1/4" F/Sq	8 lbs.
LTT100i	068403	10 - 100 lbf.in	113 - 1130 cN.m	11.5 - 115 kgf.cm	1/4" F/Sq	8 lbs.
LTT250i	068404	25 - 250 lbf.in	282.5 - 2825 cN.m	28.8 - 288 kgf.cm	1/4" F/Sq	8 lbs.
LTT50F	068405	5 - 50 lbf.ft	6.8 - 67.8 N.m	0.7 - 6.9 kgf.m	3/8" F/Sq	8 lbs.
LTT100F	068406	10 - 100 lbf.ft	13.56 - 135.6 N.m	1.4 - 13.8 kgf.m	1/2" F/Sq	8 lbs.
LTT250F	068407	25 - 250 lbf.ft	33.9 - 339 N.m	3.5 - 34.5 kgf.m	1/2" F/Sq	8 lbs.

CABLE CHART

Transducer	Cable Item #
RTSX-A	072000
All BLRTSX models	072001
BMX	072002
LPX	072003
SDX	072004
RTSX	072005
ETX	072006

ACCESSORIES INCLUDED

- Universal Charger (100 - 240VAC)
- USB Cable
- Mountz Software Programs
- Run Down Adapter Case

ACCESSORIES OPTIONAL

Description	Item #
Charger 100 - 240VAC	770300
USB Cable	770319
Battery Pack	072506
Multiplexer	072998
Bar Code Reader	072997
Mounting Bracket (for LTT model 10i-50F)	072608
Mounting Bracket (for all other LTT models)	072606
PLC Interface	072014

CE
RoHS



Since a tester cannot always duplicate actual joint characteristic, the torque reading displayed on the LTT may vary from the actual torque that a tool will apply to a joint. When critical assemblies are involved, the torque output of the power tool being used should be verified on the actual assembly using a calibrated measuring torque tool.



Supplied with NIST-Traceable Certification of Calibration

TorqueMate®

PTT Series

Torque, Angle & Force Analyzer
with ARCII Technology

Torque
Analyzers

KEY FEATURES

System Accuracy $\pm 0.5\%$ of reading from 20% to 100% of full scale.
System Accuracy $\pm 1\%$ of reading from 10% to 20% of full scale.

Operates with Torque & Force sensors.

Recommended for all hand screwdrivers, wrenches or power tools.

Provides "EZ-Plug & Play" with Mountz Transducers, Features "ARCII" technology, an instant auto-recognition system of the transducer connected to the PTT.

Selection of six/seven operation modes:
Track, Peak, First Peak, Audit, Bolt Audit*, Spindle Audit, Torque + Angle.

*The Bolt Audit Mode is an additional feature that is only available with PTT Bolt Audit Model (Item #072995).

Seven units of torque measurements:
ozf.in, lbf.in, lbf.ft, cN.m, N.m, kgf.m, kgf.cm

Two units of force measurement: lbf and kN

Features built-in Tool Tests operation.

Includes three PC Windows based software programs:

Mountz Torque Meter Interface Program
for sensor calibrations, meter calibration and tool tests.

Torque Meter Bootloader
for updating the PTT operating systems.

Excell Add-In
for Real-Time data collection into an Excel spreadsheet.
It provides statistic calculations.

"Flash" memory allows upgrades to be done by the user in the field & internet through the USB port.

Five low-pass filters: 3000, 2000, 1500, 500, and 200Hz

Six-digit display and easy to read menu structure.

Real Time Clock for time stamping of readings.

USB interface to download readings to PC.

High Capacity Li-ion Batteries for long life (30 hours with standard transducers and 16 hours with brushless rotary).

Can connect to most mv/v transducers and can store calibration data for up to 50 non-smart torque sensors.

The 5VDC capability allows unit to be used with a Brushless Rotary Transducer for testing pulse tools and high RPM tools.

Torque and Angle data is displayed simultaneously when used with Torque and Angle transducers, up to 8000 RPM for angle measurement.

Stores a total of 5000 data points.

Real time graph of torque vs. time using associated PC Windows software.

Features Go / No Go LEDs that illuminate when high or low setting is achieved.



Tool Tests & Graphing

The PTT allows you to set up and create tool tests and save the readings so you can export the data to a PC for documentation. It is the ideal solution for organizing and storing test data for ISO and SPC documentation.

The ability to graph a dynamic rundown allows joint analysis. Great resource to evaluate, create or confirm a torque specification or tool being used in production.



CERTIFIED

Supplied with NIST-Traceable Certification of Calibration



PLUG & PLAY



NOTE!

Since a tester cannot always duplicate actual joint characteristics, the torque reading displayed on the PTT may vary from the actual torque that a tool will apply to a joint. When critical assemblies are involved, the torque output of the power tool being used should be verified on the actual assembly using a calibrated measuring torque tool.

PTT-2000 Item #072999

PTT-2000 Bolt Audit Model
(for HSD Multipliers) - Item #072995

ACCESSORIES INCLUDED

Universal Charger (100 - 240VAC)
USB Cable
Mountz Software Programs
Protective Cover

ACCESSORIES OPTIONAL

Description	Item #
Charger 100 - 240VAC	770300
USB Cable	770319
Battery Pack	072506
Multiplexer	072998
Bar Code Reader	072997
PLC Interface	072014

CABLE CHART

Transducer	Item #
RTSX-A	072000
All BLRTSX Models	072001
BMX	072002
LPX	072003
SDX	072004
RTSX	072005
ETX	072006

CE RoHS



Torque Analyzers

KEY FEATURES

- System accuracy $\pm 0.5\%$ of reading from 10% to 100%.
- Easy to use "Windows" and "Pocket" PC software for Torque and Force measurement.
- Ideal laboratory system when used with PC or Laptop.
- Takes calibration to the production line when used with a PDA/Laptop.
- Enables calibration and analysis of hand and power torque tools.
- Two test mode options: SPC Testing & ISO 6789 Testing.
- Instant on-screen SPC (Statistical Process Control) results from the readings collected.
- Ability to test and produce tool Calibration Certificates to ISO 6789
- Instant graph of Torque vs Time.
- Seamless transfer of data, graphs, and SPC results to Microsoft Excel.
- Easy-to-use menu system.
- All major units of Torque and Force supported.
- Four mode options - Track, Peak, 1st Peak, and Power Tool.
- Almost infinite memory capacity (dependent on memory of host PDA/PC).
- Compatible with most industry standard Torque and Force Transducers.

Wizard Plus

PDA Torque & Force Analyzer

The Wizard Plus is a CF2 Card that plugs into a Pocket PC or Laptop/PC. The Wizard Plus comes with a CF2 to PCMCIA Adapter. A Pocket PC and/or Laptop are not included and must be purchased separately.

It can be used for torque calibration, joint testing, auditing or for force and load measurement or verification of load cells.



CERTIFIED

Supplied with NIST-Traceable Certification of Calibration



MINIMUM REQUIREMENTS

- Laptop/PC with PCMCIA Slot
- Intel Pentium III Processor
- CD-ROM Drive
- Windows 98, NT4
- Windows 2000, XP Pro
- Microsoft Activesync 3.x or above
- Microsoft Excel 97 or above

- P.D.A. (Personal Digital Assistant)
- with a CF2 Slot
- running Microsoft Pocket PC



WIZARD PLUS

(Wizard Plus CF2 Card & CF2 to PCMCIA Adapter)
Item #065080



CABLE CHART

Transducer	Item #
BMX	065180
RTSX	065181
SDX	065182
LPX	065183
ETX	065188

SMX - Contact Customer Service.



The user-friendly interface makes it quick and simple to setup your torque testing parameters for hand or power tools.

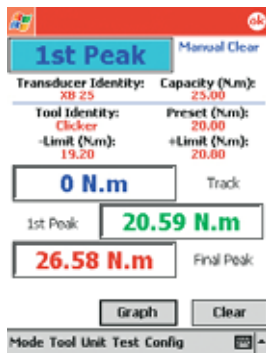

The readings are displayed along with tool identification and preset information when a load is applied.

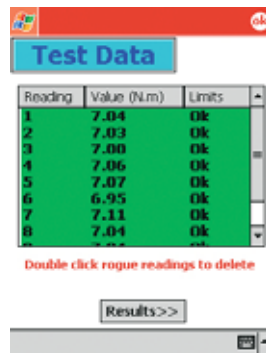

Perform and save test data for tools. The files are saved as an Excel document.

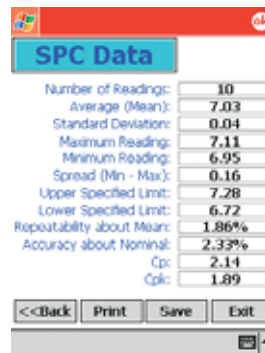

The Wizard Plus is the ideal solution for organizing and storing test data for ISO & SPC documentation.

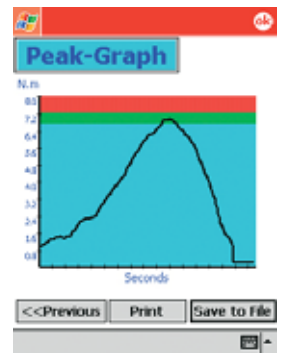

The graphing feature can be utilized to evaluate and confirm torque specifications in both production or R & D environments.



Dial Analyzers

Hand Tool Torque Analyzers



REVERSIBLE ADAPTER 1/4 M/HEX & 1/4 F/SQ.

For models: MTS 35, 130, 400



REVERSIBLE ADAPTER 1/4 F/SQ. & 3/8 F/SQ.

For models: MTS 1200, 2500

KEY FEATURES

- Accuracy $\pm 2\%$ of reading from 20% to 100% of full scale.
- Easy to read dual scale (Metric & American)
- Memory style master pointer retains maximum readings.
- Designed for all types of hand torque wrenches and screwdrivers.
- Bench mount style.
- Clockwise direction only (MTS models).
- Reversible drive adapters provide two drive options per model (MTS models).
- New robust and modern design includes angled dial for easy viewing (MTS models).
- Spindle lock eliminate the need to remove tool from drive during torque adjustment (MTS models).
- Input drive shock absorber protects from tool kick back (MTS models).
- Bi-directional & fitted with 1/4" Male hex drive (MTP model).
- Dial mirror eliminates parallax error. Uses pendulum effect to measure the applied torque (MTP model).



CERTIFIED

Supplied with NIST-Traceable
Certification of Calibration

Model	Item #	Torque Ranges	
		American	S.I.
MTP 10	020000	0 - 14 ozf.in	0 - 10 cN.m
MTS 35	020001	10 - 50 ozf.in	7 - 35 cN.m
MTS 130	020002	36 - 180 ozf.in	26 - 130 cN.m
MTS 400	020003	7 - 36 lbf.in	0.8 - 4 N.m
MTS 1200	020004	24 - 120 lbf.in	2.4 - 12 N.m
MTS 2500	020005	44 - 220 lbf.in	5 - 25 N.m

Model	Graduation		Pointer	Weight	
	American	S.I.		lbs.	kg.
MTP 10	1 ozf.in	0.5 cN.m	Single	2.16	0.98
MTS 35	0.5 ozf.in	0.5 cN.m	Memory	7.1	3.2
MTS 130	2 ozf.in	2 cN.m	Memory	7.1	3.2
MTS 400	0.5 lbf.in	0.05 N.m	Memory	7.1	3.2
MTS 1200	2 lbf.in	0.2 N.m	Memory	7.1	3.2
MTS 2500	5 lbf.in	0.5 N.m	Memory	7.1	3.2



NOTE!

Do not use with electric or pneumatic tools.



LPX

Low Profile Torque Reaction Transducer with ARC II Technology

Model	Item #	Torque Ranges	
		American	S.I.
LPX10z	079000	1 - 10 ozf.in	0.7 - 7.1 cN.m
LPX20z	079001	2 - 20 ozf.in	1.5 - 14 cN.m
LPX40z	079002	4 - 40 ozf.in	2.9 - 28.2 cN.m
LPX80z	079003	8 - 80 ozf.in	5.7 - 56.5 cN.m
LPX160z	079004	16 - 160 ozf.in	11.3 - 113 cN.m
LPX20i	079005	2 - 20 lbf.in	22.6 - 226 cN.m

DRIVE SIZE & DIMENSIONS

Model	Drive Size	A	B	C
LPX10z	1/4 Female Square	1.6	2.55	1
LPX20z	1/4 Female Square	1.6	2.55	1
LPX40z	1/4 Female Square	1.6	2.55	1
LPX80z	1/4 Female Square	1.6	2.55	1
LPX160z	1/4 Female Square	1.6	2.55	1
LPX20i	1/4 Female Square	1.6	2.55	1

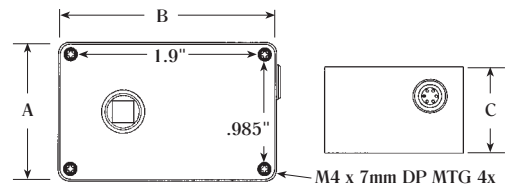

Accessories



RUN DOWN ADAPTERS

Provides consistent and reliable torque readings for use with power driven torque control tools.
See Page 01.20



TLS MINIMASTER

Torque Limiting Screwdriver Internally Adjustable
(For hand torque screwdrivers, ask for our "assembly tools" catalog).

KEY FEATURES

- Accuracy $\pm 0.25\%$ of full scale.
- For calibrating low torque hand screwdrivers, wrenches, and power tools.
- The low profile design makes it ideal for calibrating robotic drivers on the assembly line.
- Various models that range from 1 ozf.in to 20 lbf.in.
- Features "ARCII" technology, an instant auto-recognition system of the LPX connected to the PTT or LTT.
- Mountable.
- 1/4" female square drive.
- Bi-directional.



CERTIFIED

Supplied with NIST-Traceable Certification of Calibration



WARNING!

Always use a run down adapter when testing power tools.



PLUG & PLAY

SPECIFICATIONS

- Rated Output: 2mv/v Nominal
- Safe Overload: 125% of Rated Output
- Bridge Resistance: 350 Ohms Nominal
- Nonlinearity: $\pm 0.1\%$ of Rated Output



LPX CABLE

Item #072003

For connecting to PTT or LTT

Item #065183

For connecting to Wizard Plus

CONNECTION

- 1 = Signal (+)
- 2 = Signal (-)
- 3 = Excitation (-)
- 4 = Excitation (+)
- 5 = Ground
- 6 = Data



MOUNTING BRACKET

Item #062109

Model: MB-1
Dimensions: 4" x 3" x 4"

BMX

Torque Reaction Transducer with ARCII Technology

Model	Item #	Torque Ranges	
		American	S.I.
BMX20z	077000	2 - 20 ozf.in	1.5 - 14 cN.m
BMX40z	077001	4 - 40 ozf.in	2.9 - 28.2 cN.m
BMX80z	077002	8 - 80 ozf.in	5.7 - 56.5 cN.m
BMX10i	077003	1 - 10 lbf.in	11.3 - 113 cN.m
BMX25i	077004	2.5 - 25 lbf.in	28 - 282.5 cN.m
BMX50i	077005	5 - 50 lbf.in	56.5 - 565 cN.m
BMX100i	077006	10 - 100 lbf.in	113 - 1130 cN.m
BMX250i	077007	25 - 250 lbf.in	282.5 - 2825 cN.m
BMX500i	077008	50 - 500 lbf.in	565 - 5650 cN.m
BMX750i	077009	75 - 750 lbf.in	847 - 8473 cN.m
BMX50F	077010	5 - 50 lbf.ft	6.8 - 67.8 N.m
BMX100F	077011	10 - 100 lbf.ft	13.6 - 135.6 N.m
BMX250F	077012	25 - 250 lbf.ft	33.9 - 339 N.m
BMX500F	077013	50 - 500 lbf.ft	67.8 - 678 N.m
BMX1000F	077014	100 - 1000 lbf.ft	135.6 - 1355 N.m
BMX2500F	077015	250 - 2500 lbf.ft	339 - 3389 N.m
BMX5000F	077016	500 - 5000 lbf.ft	678 - 6779 N.m
BMX10000F	077017	1000 - 10000 lbf.ft	1335 - 13558 N.m
BMX20000F	077018	2000 - 20000 lbf.ft	2711 - 27116 N.m

SPECIFICATIONS

Rated Output: 2mv/v Nominal Bridge Resistance: 350 Ohms Nominal
 Safe Overload: 125% of Rated Output Nonlinearity: ± 0.1% of Rated Output

DIMENSIONS

Model	A	B	C	D	E	Drive Size
BMX20z	2.75	2.1	1.7	0.25	2.175	1/4
BMX40z	2.75	2.1	1.7	0.25	2.175	1/4
BMX80z	2.75	2.1	1.7	0.25	2.175	1/4
BMX10i	2.75	2.1	1.7	0.25	2.175	1/4
BMX25i	2.75	2.1	1.7	0.25	2.175	1/4
BMX50i	2.75	2.1	1.7	0.25	2.175	1/4
BMX100i	2.75	2.1	1.7	0.25	2.175	1/4
BMX250i	2.75	2.1	1.7	0.25	2.175	1/4
BMX500i	2.75	2.1	1.7	0.25	2.175	3/8
BMX750i	2.75	2.1	1.75	0.25	2.175	3/8
BMX50F	2.75	2.1	1.75	0.25	2.175	3/8
BMX100F	4	2.75	2.25	0.413	3	1/2
BMX250F	4	2.75	2.25	0.413	3	1/2
BMX500F	4	3	2.4	0.413	3	3/4
BMX1000F	4	3.75	2.38	0.406	3	1
BMX2500F	6	4.65	3.88	0.531	4.75	1 1/2
BMX5000F	6	4.65	3.88	0.531	4.75	1 1/2
BMX10000F	10.5	10.5	6.5	0.781*	8.875	2 1/2
BMX20000F	10.5	10.5	6.5	0.781*	8.875	2 1/2

*Models have 8 mounting holes.

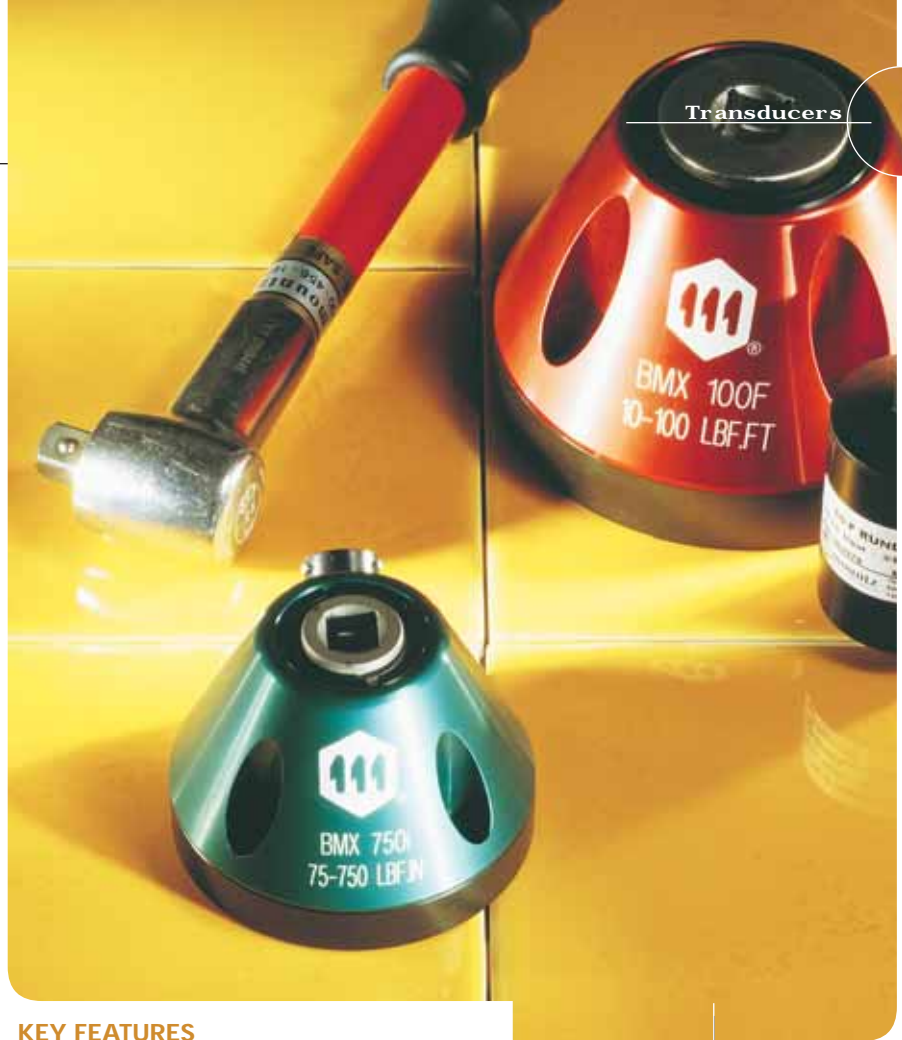
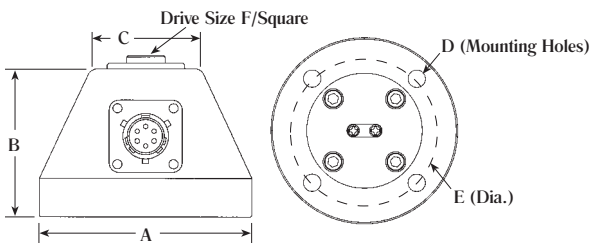

KEY FEATURES

Accuracy ± 0.25% of full scale
 Accuracy ± 0.5% of full scale (BMX10000F, 20000F)

For calibrating hand screwdrivers, wrenches, and power tools.

Various models that range from 2 ozf.in to 20000 lbf.ft.

Features "ARCII" technology, an instant auto-recognition system of the BMX connected to the LTT & PTT.

Mountable.

Female square drive.

Bi-directional.

BMX CABLES

Item #072002

For connecting to LTT or PTT

Item #065180

For connecting to Wizard Plus

CONNECTION

- A = Excitation (+)
- B = Excitation (-)
- C = Signal (-)
- D = Signal (+)
- E = N/A
- F = N/A

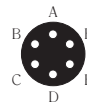

MOUNTING BRACKET

See Page 01.19



EZ PLUG & PLAY

CERTIFIED

Supplied with NIST-Traceable Certification of Calibration

WARNING!

Always use a run down adapter when testing power tools.
 Not recommended for impact wrenches.

Connect With A:



LTT

Offers "EZ-Plug & Play" with instant auto recognition with Mountz "ARCII" transducers.
 See Page 01.3



PTT

A portable, accurate and versatile Torque & Angle Analyzer that fits comfortably in the hand.
 See Page 01.4

RTSX

Rotary Torque Transducer with ARCII Technology



Transducers

Model	Item #	Torque Ranges	
		American	S.I.
RTSX10i-H	170200	1 - 10 lbf.in	11.3 - 113 cN.m
RTSX10i	170201	1 - 10 lbf.in	11.3 - 113 cN.m
RTSX50i-H	170202	5 - 50 lbf.in	56.5 - 565 cN.m
RTSX50i	170203	5 - 50 lbf.in	56.5 - 565 cN.m
RTSX100i-H	170204	10 - 100 lbf.in	113 - 1130 cN.m
RTSX100i	170205	10 - 100 lbf.in	113 - 1130 cN.m
RTSX200i-H	170206	20 - 200 lbf.in	226 - 2260 cN.m
RTSX200i	170207	20 - 200 lbf.in	226 - 2260 cN.m
RTSX50F	170208	5 - 50 lbf.ft	6.8 - 67.8 N.m
RTSX100F	170209	10 - 100 lbf.ft	13.6 - 135.6 N.m
RTSX400F	170210	40 - 400 lbf.ft	54.2 - 542.4 N.m
RTSX738F	170211	74 - 738 lbf.ft	100 - 1000 N.m
RTSX1500F	170212	150 - 1500 lbf.ft	203.3 - 2033 N.m

DRIVE SIZE

Model	Input	Output
RTSX10i-H	1/4 Male/Hex	1/4 Female/Hex
RTSX10i	1/4 Female/Square	1/4 Male/Square
RTSX50i-H	1/4 Male/Hex	1/4 Female/Hex
RTSX50i	1/4 Female/Square	1/4 Male/Square
RTSX100i-H	1/4 Male/Hex	1/4 Female/Hex
RTSX100i	1/4 Female/Square	1/4 Male/Square
RTSX200i-H	1/4 Male/Hex	1/4 Female/Hex
RTSX200i	3/8 Female/Square	3/8 Male/Square
RTSX50F	3/8 Female/Square	3/8 Male/Square
RTSX100F	1/2 Female/Square	1/2 Male/Square
RTSX400F	3/4 Female/Square	3/4 Male/Square
RTSX738F	1 Female/Square	1 Male/Square
RTSX1500F	1 1/2 Female/Square	1 1/2 Male Square

KEY FEATURES

Accuracy $\pm 0.25\%$ of full scale.

Use with most hand tools, power tools, or rotational measurement applications.

Connects between the power tool and the joint. Monitors actual torque being applied from the driver to the fastener.

Features "ARCII" technology, an instant auto-recognition system of the RTSX connected to the PTT or LTT.

Bi-directional.

RTSX CABLES

Item #072005
For connecting to PTT or LTT

Item #065181
For connecting to Wizard Plus

CONNECTION

- A = Excitation (+)
- B = Excitation (-)
- C = Output (-)
- D = Output (+)
- E = Shield
- F = 100% control (full scale)

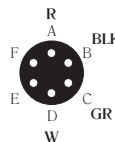

Connect With A:



ANALYZER

- Wizard Plus (shown) See Page 01.5
- LTT See Page 01.3
- PTT See Page 01.4



CERTIFIED

Supplied with NIST-Traceable Certification of Calibration



WARNING!

Not recommended for impact wrenches.



PLUG & PLAY

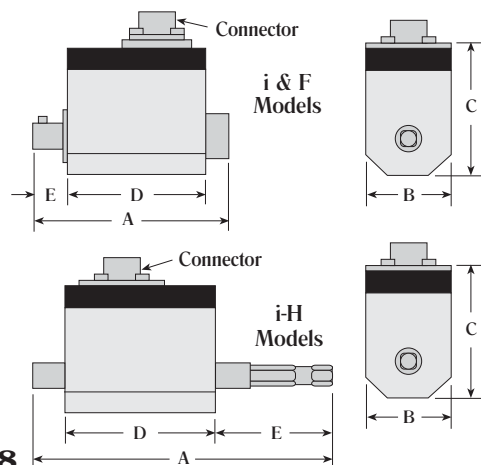

SPECIFICATIONS

Output at Rated Capacity: ≤ 6 Nm [53 lbf.in] rated torque 1 mV/V
 > 6 Nm [53 lbf.in] rated torque 2 mV/V

Interchangeability: Matched for mv/v and shunt calibration + 0.3% FS

Nonlinearity: + 0.2% FS

Excitation Recommended: 10V DC or AC RMS

Bridge Resistance: 350 Ohms

Usable Temperature Range: 41 - 122 °F

Mating Connector: Bendix PT06A-10-65 (SR)

Safe Overload: 125% of Rated Output

DIMENSIONS

Model	A	B	C	D	E
RTSX10i-H	101	28	52	58	28
RTSX10i	75	28	52	58	8.5
RTSX50i-H	101	28	52	58	28
RTSX50i	75	28	52	58	8.5
RTSX100i-H	101	28	52	58	28
RTSX100i	75	28	52	58	8.5
RTSX200i-H	101	28	52	58	28
RTSX200i	74.5	38	58	44	18
RTSX50F	74.5	38	58	44	18
RTSX100F	79	38	58	44	22.5
RTSX400F	97	58	76	50	30
RTSX738F	112	73	90	57	34.5
RTSX1500F	165	110	126	87	44

RTSX-A

Rotary Torque & Angle Transducer with ARCII Technology

Model	Item #	Torque Ranges	
		American	S.I.
RTSX10i-HA	170213	1 - 10 lbf.in	11.3 - 113 cN.m
RTSX10i-A	170214	1 - 10 lbf.in	11.3 - 113 cN.m
RTSX50i-HA	170215	5 - 50 lbf.in	56.5 - 565 cN.m
RTSX50i-A	170216	5 - 50 lbf.in	56.5 - 565 cN.m
RTSX100i-HA	170217	10 - 100 lbf.in	113 - 1130 cN.m
RTSX100i-A	170218	10 - 100 lbf.in	113 - 1130 cN.m
RTSX200i-HA	170219	20 - 200 lbf.in	226 - 2260 cN.m
RTSX200i-A	170220	20 - 200 lbf.in	226 - 2260 cN.m
RTSX50F-A	170221	5 - 50 lbf.ft	6.8 - 67.8 N.m
RTSX100F-A	170222	10 - 100 lbf.ft	13.6 - 135.6 N.m
RTSX400F-A	170223	40 - 400 lbf.ft	54.2 - 542.4 N.m
RTSX800F-A	170224	80 - 800 lbf.ft	108.4 - 1084 N.m
RTSX1500F-A	170282	150 - 1500 lbf.ft	203.3 - 2033 N.m

SPECIFICATIONS

Output at Rated Capacity: $\leq 6 \text{ Nm [53 lbf.in]}$ rated torque 1 mV/V
 $> 6 \text{ Nm [53 lbf.in]}$ rated torque 2 mV/V

Interchangeability: Matched for mv/v and
 Shunt Calibration + 0.3% FS

Nonlinearity: + 0.2% FS

Excitation Recommended: 12V DC or AC RMS

Bridge Resistance: 350 Ohms

Usable Temperature Range: 41 - 122°F

Mating Connector: Bendix PT06A-12

Safe Overload: 125% of Rated Output

DRIVE SIZE

Model	Input	Output
RTSX10i-HA	1/4 Male/Hex	1/4 Female/Hex
RTSX10i-A	1/4 Female/Square	1/4 Male/Square
RTSX50i-HA	1/4 Male/Hex	1/4 Female/Hex
RTSX50i-A	1/4 Female/Square	1/4 Male/Square
RTSX100i-HA	1/4 Male/Hex	1/4 Female/Hex
RTSX100i-A	1/4 Female/Square	1/4 Male/Square
RTSX200i-HA	1/4 Male/Hex	1/4 Female/Hex
RTSX200i-A	1/4 Female/Square	1/4 Male/Square
RTSX50F-A	3/8 Female/Square	3/8 Male/Square
RTSX100F-A	1/2 Female/Square	1/2 Male/Square
RTSX400F-A	3/4 Female/Square	3/4 Male/Square
RTSX800F-A	1 Female/Square	1 Male/Square
RTSX1500F-A	1 1/2 Female/Square	1 1/2 Male/Square

 **CERTIFIED**
 Supplied with NIST-Traceable
 Certification of Calibration

 **WARNING!**
 Not recommended for impact wrenches.

 **PLUG & PLAY**



KEY FEATURES

Accuracy $\pm 0.25\%$ of full scale.

Ability to measure the rotation angle of a fastener.
 Joint rate and breakaway torque can be measured too.

Angle Output: 2 channel quadrature, 360 pulses per rotation.

Bi-directional.

For use with most power tools or rotational measurement applications.

Features "ARCII" technology, an instant auto-recognition system of the RTSX-A connected to the PTT or LTT.

DIMENSIONS

Model	A	B	C	D	E
RTSX10i-HA	101	28	52	58	28
RTSX10i-A	75	28	52	58	8.5
RTSX50i-HA	101	28	52	58	28
RTSX50i-A	75	28	52	58	8.5
RTSX100i-HA	101	28	52	58	28
RTSX100i-A	75	28	52	58	8.5
RTSX200i-HA	101	28	52	58	28
RTSX200i-A	75	28	52	58	8.5
RTSX50F-A	101	38	58	59	21.5
RTSX100F-A	106	38	58	59	26
RTSX400F-A	135	58	76	64	40
RTSX800F-A	177	73	90	73	57.5
RTSX1500F-A	165	110	126	87	39

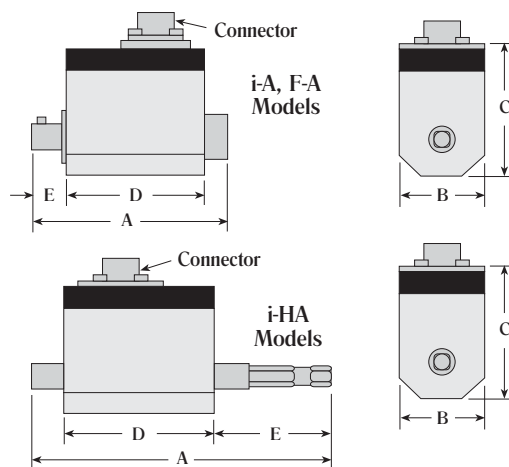

etorque.com

Transducers

Connect With A:



PTT

Ability to document and save torque readings.
 Ideal for SPC testing and ISO testing.
See Page 01.4



RTSX-A CABLE

Item #072000

For connecting to
 PTT or LTT

CONNECTION

Torque Output

- A = Bridge Voltage (+)
- B = Bridge Voltage (-)
- C = Measured Signal (+)
- D = Measured Signal (-)
- E = Ground (Angle Voltage)
- F = +5V (Angle Voltage)

Angle Output

- G = Channel A (Load)
- H = Channel B (Lag)
- I = N/A
- K = 100% Control (Full Scale)

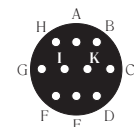



KEY FEATURES

- Accuracy $\pm 0.2\%$ of full scale.
- Non-contact signal transfer and maintenance free.
- Angle Output: 2-channel quadrature, 360 pulses per rotation.
- Ability to measure the rotation angle of a fastener. Joint rate & breakaway torque can be measured too.
- The common "brush bounce" that plagues the accuracy testing of pulse tools is cured when using a brushless rotary transducer.
- Compact design & bi-directional.
- For use with most power tools, high RPM tools, or rotational measurement applications.
- Features "ARCII" technology, an instant auto-recognition system of the BLRTSX-A connected to the PTT or LTT.



CERTIFIED

Supplied with NIST-Traceable Certification of Calibration



PLUG & PLAY



BLRTSX-A CABLE

For connecting to the PTT or LTT.

Item #072001

CONNECTION

- A = Ground (Shunt Calibration)
- B = Angle 1 Speed
- C = Torque Output
- D = Ground (Torque Output)
- E = Ground (Supply)
- F = Supply, 11-26 VDC, 1 W
- G = Angle 2
- (90° running after Angle 1)
- H = +5V (Angle Voltage)
- K = Shunt Calibration
- M = Shield
- J & L = N/A



BLRTSX-A

Brushless Rotary Torque & Angle Transducer with ARCII Technology

Model	Item #	Torque Ranges	
		American	S.I.
BLRTSX28z-HA	170283	10 - 28 ozf.in	7 - 20 cN.m
BLRTSX70z-HA	170246	10 - 70 ozf.in	7 - 49 cN.m
BLRTSX140z-HA	170247	25 - 140 ozf.in	18 - 98.8 cN.m
BLRTSX18i-HA	170248	2 - 18 lbf.in	22.5 - 203 cN.m
BLRTSX50i-HA	170249	5 - 50 lbf.in	56.5 - 565 cN.m
BLRTSX100i-HA	170250	10 - 100 lbf.in	113 - 1130 cN.m
BLRTSX100i-A	170251	10 - 100 lbf.in	113 - 1130 cN.m
BLRTSX160i-HA	170252	16 - 160 lbf.in	180 - 1807 cN.m
BLRTSX160i-A	170253	16 - 160 lbf.in	180 - 1807 cN.m
BLRTSX36F-A	170254	4 - 36 lbf.ft	5 - 50 N.m
BLRTSX73F-A	170255	8 - 73 lbf.ft	10 - 100 N.m
BLRTSX118F-A	170256	12 - 118 lbf.ft	16 - 160 N.m
BLRTSX184F-A	170257	19 - 184 lbf.ft	25 - 250 N.m
BLRTSX368F-A	170258	37 - 368 lbf.ft	50 - 500 N.m
BLRTSX738F-A	170259	74 - 738 lbf.ft	100 - 1000 N.m

SPECIFICATIONS

- Rated Output: $\pm 5\text{VDC} \pm 0.2\% \text{ FS}$
- Excitation Recommended: 11VDC to 26VDC (pole secure)
- Nonlinearity: $\pm 0.2\% \text{ FS}$
- Usable Temperature Range 41 to 122°F
- Mating Connector: Tuchel Series 581 (98-2030-09-12)
- Safe Overload: 150% of Rated Output

Model	Drive Size (inches)		Dimensions (mm)				
	Input	Output	A	B	C	D	E
BLRTSX28z-HA	1/4 M/Hex	1/4 F/Hex	101	28	52	58	28
BLRTSX70z-HA	1/4 M/Hex	1/4 F/Hex	101	28	52	58	28
BLRTSX140z-HA	1/4 M/Hex	1/4 F/Hex	101	28	52	58	28
BLRTSX18i-HA	1/4 M/Hex	1/4 F/Hex	101	28	52	58	28
BLRTSX50i-HA	1/4 M/Hex	1/4 F/Hex	101	28	52	58	28
BLRTSX100i-HA	1/4 M/Hex	1/4 F/Hex	101	28	52	58	28
BLRTSX100i-A	1/4 F/Sq	1/4 M/Sq	75	28	52	58	8.5
BLRTSX160i-HA	1/4 M/Hex	1/4 F/Hex	101	28	52	58	28
BLRTSX160i-A	1/4 F/Sq	1/4 M/Sq	75	28	52	58	8.5
BLRTSX36F-A	3/8 F/Sq	3/8 M/Sq	101	38	58	59	21.5
BLRTSX73F-A	1/2 F/Sq	1/2 M/Sq	106	38	58	59	26
BLRTSX118F-A	1/2 F/Sq	1/2 M/Sq	106	38	58	59	26
BLRTSX184F-A	3/4 F/Sq	3/4 M/Sq	135	58	76	64	40
BLRTSX368F-A	3/4 F/Sq	3/4 M/Sq	135	58	76	64	40
BLRTSX738F-A	1 F/Sq	1 M/Sq	177	73	90	73	57.5

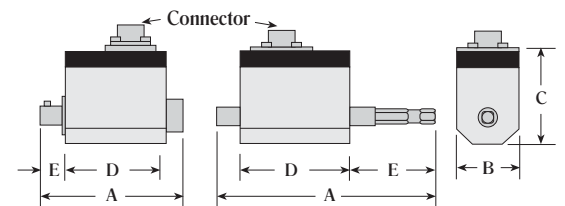

i-A & FA Models z-HA, i-HA Models

Threads for mounting M4, 6mm depth.

BLRTSX

Brushless Rotary Torque Transducer with ARC II Technology

Model	Item #	Torque Ranges	
		American	S.I.
BLRTSX28z-H	170225	10 - 28 ozf.in	7 - 20 cN.m
BLRTSX70z-H	170226	10 - 70 ozf.in	7 - 49 cN.m
BLRTSX140z-H	170227	25 - 140 ozf.in	18 - 98.8 cN.m
BLRTSX18i-H	170228	2 - 18 lbf.in	22.5 - 203 cN.m
BLRTSX50i-H	170229	5 - 50 lbf.in	56.5 - 565 cN.m
BLRTSX50i	170230	5 - 50 lbf.in	56.5 - 565 cN.m
BLRTSX100i-H	170231	10 - 100 lbf.in	113 - 1130 cN.m
BLRTSX100i	170232	10 - 100 lbf.in	113 - 1130 cN.m
BLRTSX160i-H	170232	16 - 160 lbf.in	180 - 1807 cN.m
BLRTSX160i	170234	16 - 160 lbf.in	180 - 1807 cN.m
BLRTSX18F	170235	2 - 18 lbf.ft	2.5 - 25 N.m
BLRTSX36F	170236	4 - 36 lbf.ft	5 - 50 N.m
BLRTSX73F	170237	8 - 73 lbf.ft	10 - 100 N.m
BLRTSX118F	170238	12 - 118 lbf.ft	16 - 160 N.m
BLRTSX184F	170239	19 - 184 lbf.ft	25 - 250 N.m
BLRTSX368F	170240	37 - 368 lbf.ft	50 - 500 N.m
BLRTSX738F	170241	74 - 738 lbf.ft	100 - 1000 N.m

DRIVE SIZE

Model	Input	Output
BLRTSX28z-H	1/4 Male/Hex	1/4 Female/Hex
BLRTSX70z-H	1/4 Male/Hex	1/4 Female/Hex
BLRTSX140z-H	1/4 Male/Hex	1/4 Female/Hex
BLRTSX18i-H	1/4 Male/Hex	1/4 Female/Hex
BLRTSX50i-H	1/4 Male/Hex	1/4 Female/Hex
BLRTSX50i	1/4 Female/Square	1/4 Male/Square
BLRTSX100i-H	1/4 Male/Hex	1/4 Female/Hex
BLRTSX100i	1/4 Female/Square	1/4 Male/Square
BLRTSX160i-H	1/4 Male/Hex	1/4 Female/Hex
BLRTSX160i	1/4 Female/Square	1/4 Male/Square
BLRTSX18F	3/8 Female/Square	3/8 Male/Square
BLRTSX36F	3/8 Female/Square	3/8 Male/Square
BLRTSX73F	1/2 Female/Square	1/2 Male/Square
BLRTSX118F	1/2 Female/Square	1/2 Male/Square
BLRTSX184F	3/4 Female/Square	3/4 Male/Square
BLRTSX368F	3/4 Female/Square	3/4 Male/Square
BLRTSX738F	1 Female/Square	1 Male/Square



Supplied with NIST-Traceable Certification of Calibration



SPECIFICATIONS

- Rated Output: $\pm 5\text{VDC} \pm 0.2\%$ FS
- Excitation Recommended: 11VDC to 26VDC (pole secure)
- Nonlinearity: $\pm 0.2\%$ FS
- Usable Temperature Range 41 - 122°F
- Mating Connector: Tuchel Series 581 (98-2030-09-12)
- Safe Overload: 150% of Rated Output



Transducers

KEY FEATURES

- Accuracy $\pm 0.2\%$ of full scale.
- Non-contact signal transfer and maintenance free.
- The common "brush bounce" that plagues the accuracy testing of pulse tools is cured when using a BLRTSX.
- Bi-directional.
- Compact design.
- For use with most power tools, high RPM tools, or rotational measurement applications.
- Features "ARCII" technology, an instant auto-recognition system of the BLRTSX connected to the PTT or LTT.

DIMENSIONS

Model	A	B	C	D	E
BLRTSX28z-H	101	28	52	58	28
BLRTSX70z-H	101	28	52	58	28
BLRTSX140z-H	101	28	52	58	28
BLRTSX18i-H	101	28	52	58	28
BLRTSX50i-H	101	28	52	58	28
BLRTSX50i	75	28	52	58	8.5
BLRTSX100i-H	101	28	52	58	28
BLRTSX100i	75	28	52	58	8.5
BLRTSX160i-H	101	28	52	58	28
BLRTSX160i	75	28	52	58	8.5
BLRTSX18F	74.5	38	58	44	18
BLRTSX36F	74.5	38	58	44	18
BLRTSX73F	79	38	58	44	22.5
BLRTSX118F	79	38	58	44	22.5
BLRTSX184F	97	58	76	50	30
BLRTSX368F	97	58	76	50	30
BLRTSX738F	112	73	90	57	34.5



RUN DOWN ADAPTERS

Provides consistent and reliable torque readings for use with power driven torque control tools.

See Page 01.19



BLRTSX CABLE

Item #072001
For connecting to PTT or LTT

CONNECTION

- A = Ground
- (Shunt Calibration)
- C = Torque Output
- D = Ground (Torque Output)
- E = Ground (Supply)
- F = Supply, 11-26 VDC, 1 W
- K = Shunt Calibration
- M = Shield
- B/G/H/J/L = N/A

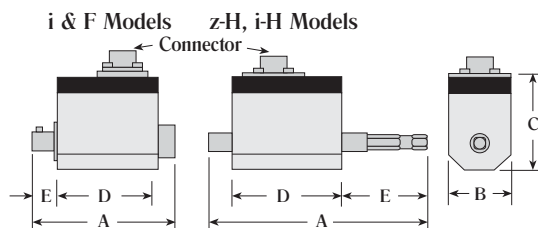



BLRTSX-R/RA

**Brushless Rotary Torque & Angle Shaft Transducer
with ARCII Technology**

SPECIFICATIONS

Rated Output: $\pm 5\text{VDC} \pm 0.2\% \text{ FS}$
Excitation Recommended: 11VDC to 26VDC (pole secure)
Nonlinearity: $+ 0.2\% \text{ FS}$
Usable Temperature Range: 41 - 122° F
Mating Connector: Tuscel Series 581 (98-2030-09-12)
Safe Overload: 150% of Rated Output

NOTE!

For optimum performance, it is recommended to utilize coupling in order to minimize extraneous load & moments due to misalignment. Contact customer service for information.

CERTIFIED

Supplied with NIST-Traceable Certification of Calibration

EZ PLUG & PLAY

BLRTSX-R/RA CABLE

Item #072001

For connecting a BLRTSX-R/RA to the PTT or LTT.

BLRTSX-R PIN CONNECTION

- A = Ground (Shunt Calibration)
- C = Torque Output
- D = Ground (Torque Output)
- E = Ground (Supply)
- F = Supply, 11-26 VDC, 1 W
- K = Shunt Calibration
- M = Shield
- B/G/H/J/L = N/A

BLRTSX-RA PIN CONNECTION

- A = Ground (Shunt Calibration)
- B = Angle I Speed
- C = Torque Output
- D = Ground (Torque Output)
- E = Ground (Supply)
- F = +12V (Supply)
- G = Angle 2 (90° running after Angle 1)
- H = +5V (Angle Voltage)
- K = Shunt Calibration
- M = Shield
- J/L = N/A

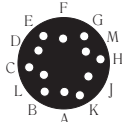

KEY FEATURES

Accuracy $\pm 0.2\%$ of full scale.

Non-contact signal transfer and maintenance free.

Compact design & bi-directional.

Used in-line with rotating shafts or nutrunners for feed back control. Motor testings, high RPM Tools or rotational measurement applications.

RA Models:

- Angle output 2-channel quadrature
- 360 pulses per rotation
- Ability to measure the rotation angle of a fastener
- Joint rate & breakaway torque can be measured too

Features "ARCII" technology, an instant auto-recognition system of the BLRTSX-R/RA connected to the PTT or LTT.

Model	Item #	Torque Ranges	
		American	S.I.
BLRTSX140z-R	170260	25 - 140 ozf.in	18 - 98.8 cN.m
BLRTSX140z-RA	170261	25 - 140 ozf.in	18 - 98.8 cN.m
BLRTSX18i-R	170262	2 - 18 lbf.in	22.5 - 203 cN.m
BLRTSX18i-RA	170263	2 - 18 lbf.in	22.5 - 203 cN.m
BLRTSX44i-R	170264	4 - 44 lbf.in	45.2 - 497 cN.m
BLRTSX44i-RA	170265	4 - 44 lbf.in	45.2 - 497 cN.m
BLRTSX89i-R	170266	10 - 89 lbf.in	113 - 1005 cN.m
BLRTSX89i-RA	170267	10 - 89 lbf.in	113 - 1005 cN.m
BLRTSX177i-R	170268	18 - 177 lbf.in	203.4 - 2000 cN.m
BLRTSX177i-RA	170269	18 - 177 lbf.in	203.4 - 2000 cN.m
BLRTSX36F-R	170270	4 - 36 lbf.ft	5 - 50 N.m
BLRTSX36F-RA	170271	4 - 36 lbf.ft	5 - 50 N.m
BLRTSX73F-RA	170272	8 - 73 lbf.ft	10 - 100 N.m
BLRTSX148F-RA	170273	15 - 148 lbf.ft	20 - 200 N.m
BLRTSX368F-RA	170274	37 - 368 lbf.ft	50 - 500 N.m
BLRTSX738F-RA	170275	74 - 738 lbf.ft	100 - 1000 N.m

R models are Torque only transducers.

RA models are Torque & Angle transducers.

* With feather keyways (2x180°)

DIMENSIONS

Model	A	B	C	D	E	F	G	N
BLRTSX140z-R	92	28	52	10	16	17	58	Shaft
BLRTSX140z-RA	92	28	52	10	16	17	58	Shaft
BLRTSX18i-R	92	28	52	10	16	17	58	Shaft
BLRTSX18i-RA	92	28	52	10	16	17	58	Shaft
BLRTSX44i-R	92	28	52	10	16	17	58	Shaft
BLRTSX44i-RA	92	28	52	10	16	17	58	Shaft
BLRTSX89i-R	92	28	52	10	16	17	58	Shaft
BLRTSX89i-RA	92	28	52	10	16	17	58	Shaft
BLRTSX177i-R	108	38	58	19	30	32	44	*
BLRTSX177i-RA	104	38	58	16	20	23	59	*
BLRTSX36F-R	108	38	58	19	30	32	44	*
BLRTSX36F-RA	104	38	58	16	20	23	59	*
BLRTSX73F-RA	125	58	76	28	27	30.5	64	*
BLRTSX148F-RA	125	58	76	28	27	30.5	64	*
BLRTSX368F-RA	197	73	90	42	58	62	73	*
BLRTSX738F-RA	197	73	90	42	58	62	73	*

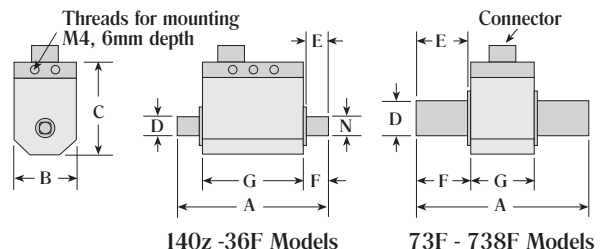

KEY FEATURES

- Accuracy $\pm 0.2\%$ of full scale.
- Non-contact signal transfer and maintenance free.
- Compact design & bi-directional.
- Features a built-in mounting base.
- Used for a variety automotive applications like starters, alternators, wiper motors, ABS, brakes, clutches, servo steering components, etc.
- Motor testing, high RPM tools or rotational measurement applications.
- Angle output: 2-channel quadrature, 360 pulses per rotation.
- Ability to measure the rotation angle of a fastener. Joint rate & breakaway torque can be measured too.
- Features "ARCII" technology, an instant auto-recognition system of the BLRTSX-RAU connected to the PTT or LTT.

SPECIFICATIONS

Rated Output: $\pm 5\text{VDC} \pm 0.2\% \text{ FS}$
Excitation Recommended: 11VDC to 26VDC (pole secure)
Nonlinearity: $+ 0.2\% \text{ FS}$
Usable Temperature Range 41 - 122°F
Mating Connector: Tuchel Series 581 (98-2030-09-12)
Safe Overload: 150% of Rated Output

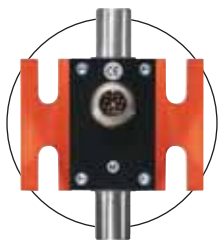

MOUNTING BASE

Top view of BLRTSX-RAU shows adjustable position of the mounting base.

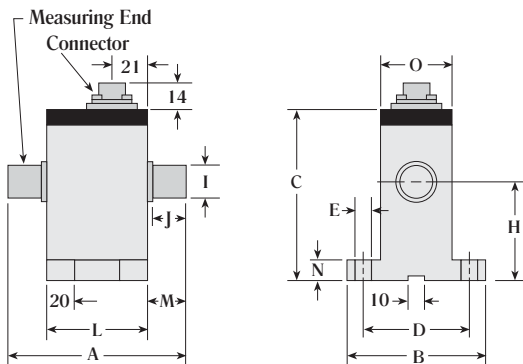

PTT

A portable, accurate and versatile Torque & Angle Analyzer that fits comfortably in the hand.

See Page 01.4

BLRTSX-RAU

Brushless Rotary Torque & Angle Transducer with Mounting Base and ARCII Technology

Model	Item #	Torque Ranges	
		American	S.I.
BLRTSX140z-RAU	170276	25 - 140 ozf.in	18 - 98.8 cN.m
BLRTSX18i-RAU	170277	2 - 18 lbf.in	22.5 - 203 cN.m
BLRTSX44i-RAU	170278	4 - 44 lbf.in	45.2 - 497 cN.m
BLRTSX89i-RAU	170279	10 - 89 lbf.in	113 - 1005 cN.m
BLRTSX177i-RAU	170280	18 - 177 lbf.in	203.4 - 2000 cN.m
BLRTSX36F-RAU	170281	4 - 36 lbf.ft	5 - 50 N.m

DIMENSIONS

Model	A	B	C	D	E	H	I	J	L	M	N	O
BLRTSX140z-RAU	90	58	83	45	7	45	10	15	58	16	12	28
BLRTSX18i-RAU	90	58	83	45	7	45	10	15	58	16	12	28
BLRTSX44i-RAU	90	58	83	45	7	45	10	15	58	16	12	28
BLRTSX89i-RAU	90	58	83	45	7	45	10	15	58	16	12	28
BLRTSX177i-RAU	106	85	102	60	9	63	14	22	59	23	15	38
BLRTSX36F-RAU	106	85	102	60	9	63	14	22	59	23	15	38

NOTE!

For optimum performance, it is recommended to utilize coupling in order to minimize extraneous load & moments due to misalignment. Contact customer service for more information.



CERTIFIED

Supplied with NIST-Traceable Certification of Calibration



PLUG & PLAY



BLRTSX-RAU CABLE

Item #072001

For connecting to a PTT or LTT.

CONNECTION

- A = Ground (Shunt Calibration)
- B = Angle 1 Speed
- C = Torque Output
- D = Ground (Torque Output)
- E = Ground (Supply)
- F = Supply, 11-26 VDC, 1 W
- G = Angle 2 (90° running after Angle 1)
- H = +5V (Angle Voltage)
- J = N/A
- K = Shunt Calibration
- M = Shield
- L = N/A

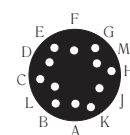

SDX

Torque Screwdriver Transducer with ARCII Technology

KEY FEATURES - SDX

Accuracy $\pm 0.25\%$ of full scale.

Transducer for auditing or tightening fasteners to a specified torque when mated with a torque analyzer.

Ergonomic rubber grip and stainless steel Female/Hex bit holder.

Features "ARCII" technology, an instant auto-recognition system of the SDX connected to the PTT or LTT.

Connect to a torque analyzer to monitor, test or audit a fastener.

Safe Overload: 125% of Rated Output.

Model	Item #	Torque Ranges	
		American	S.I.
SDX10i	078000	1 - 10 lbf.in	11.3 - 113 cN.m
SDX50i	078001	5 - 50 lbf.in	56.5 - 565 cN.m

Model	Drive Size	Length	Width	Weight
SDX10i	1/4" Female/Hex	6"	1 1/2"	0.5 lbs.
SDX50i	1/4" Female/Hex	6"	1 1/2"	0.5 lbs.



Connect With A:



LTT

Connect to a torque analyzer to monitor, test or audit a fastener.

See Page 01.3



CABLES - SDX

Item #072004

For connecting to PTT or LTT

Item #065182

For connecting to Wizard Plus

SDX CONNECTION

A = Signal (+)

B = Signal (-)

C = Excitation (-)

D = Excitation (+)

E/F = N/A



CABLES - ETX

Item #072006

For connecting to PTT or LTT

Item #065188

For connecting to Wizard Plus

ETX CONNECTION

A = Signal (-)

B = Signal (+)

C = Excitation (-)

D = Excitation (+)

E = Memory Circuit Digital Clock

F = Memory Circuit Digital I/O



ETX

Torque Wrench Transducer with ARCII Technology

KEY FEATURES - ETX

Accuracy $\pm 1\%$ of full scale.

Designed for monitoring, testing, and auditing fasteners.

Can be used for "Just Move" and "Breakaway" torque tests.

Bi-directional.

Non-length dependent.

Robust design and fixed head.

Safe Overload: 125% of Rated Output.

Features "ARCII" technology, an instant auto-recognition system of the ETX connected to the PTT or LTT.

Model	Item #	Torque Ranges	
		American	S.I.
ETX10	020176	9 - 89 lbf.in	1 - 10 N.m
ETX30	020177	2.5 - 22 lbf.ft	3 - 30 N.m
ETX100	020178	8 - 75 lbf.ft	10 - 100 N.m
ETX300	020179	22 - 220 lbf.ft	30 - 300 N.m

Model	Square Drive	Length	Width	Weight
ETX10	1/4"	8 1/2"	1 1/4"	9 oz.
ETX30	1/4"	8 1/2"	1 1/4"	9 oz.
ETX100	3/8"	17 1/2"	1 5/8"	1.5 lbs.
ETX300	1/2"	26"	2"	2.4 lbs.



CERTIFIED

Supplied with NIST-Traceable Certification of Calibration



PLUG & PLAY



SMX

Torque Socket Transducer with ARCI^{II} Technology

Model	Item #	Torque Ranges		
		American	S.I.	Metric
SMX25i	071020	2.5 - 25 lbf.in	28.2 - 282.5 cN.m	2.9 - 28.8 kgf.cm
SMX50i	071021	5 - 50 lbf.in	56.5 - 565 cN.m	5.8 - 57.6 kgf.cm
SMX100i	071022	10 - 100 lbf.in	113 - 1130 cN.m	11.5 - 115 kgf.cm
SMX50F	071023	5 - 50 lbf.ft	6.8 - 67.8 N.m	0.7 - 6.9 kgf.m
SMX200F	071024	20 - 200 lbf.ft	27.1 - 271 N.m	2.8 - 27.6 kgf.m
SMX500F	071025	50 - 500 lbf.ft	67.8 - 678 N.m	6.9 - 69.1 kgf.m

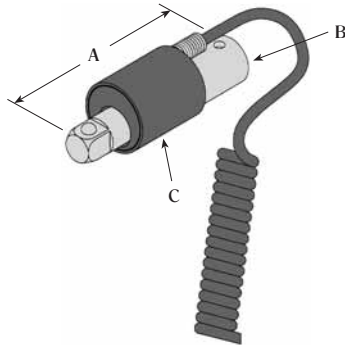

DRIVE SIZE & DIMENSIONS

Model	Square Drive	A	B	C
SMX25i	1/4"	2 (50.8)	.56 (14.2)	1 (25.4)
SMX50i	1/4"	2 (50.8)	.56 (14.2)	1 (25.4)
SMX100i	1/4"	2 (50.8)	.56 (14.2)	1 (25.4)
SMX50F	3/8"	3 (76.2)	.73 (18.5)	1.12 (28.6)
SMX200F	1/2"	3.5 (89)	.98 (24.9)	1.25 (31.8)
SMX500F	3/4"	5 (127)	1.48 (37.6)	2 (50.8)

SPECIFICATIONS

Rated Output: 2 mV/V Nominal
Zero Balance: ± 2% of Rated Output
Safe Overload: 125% of Rated Output
Excitation (VDC or VAC): 10 Recommended, 18 Maximum
Bridge Resistance: 1000 Ohms Nominal
Nonlinearity: ± 0.2% of Rated Output
Operating Temperature: -40 to 180°F (-40 to 82°C)



CERTIFIED

Supplied with NIST-Traceable Certification of Calibration



PLUG & PLAY

For Torque Screwdrivers, Torque Wrenches & Electric Screwdrivers, ask for our "Assembly Tools" catalog.



Transducers

KEY FEATURES

- Accuracy ± 0.25% of full scale.
- Various models that range 2.5 lbf.in to 500 lbf.ft.
- Bi-directional.
- Compact and robust housing.
- Converts any ratchet wrench into torque sensor.
- Ideal for applications with limited space accessibility.
- Features "ARCI^{II}" technology, an instant auto-recognition system of the SMX connected to the PTT & LTT.



CALIBRATION HEX STEP ADAPTER

Allows multiple size wrenches to be used with one adapter.

See Page 01.20



TITAN TORQUE WRENCH

Connect the SMX to the square drive of a wrench and monitor the torque applied.

Loading Bench

Calibrating Wrenches



LB750F
(BMX Transducer not included)

KEY FEATURES

A calibration system designed to enable accurate calibration of torque wrenches.

The laboratory grade instrument assures accurate torque calibration and pre-setting, independent of human influence or transducer side and end load factors.

The drive system assures the load application, eliminating the operator induced test error.

Built for durable use, the Loading Bench reduces the operator effort required to attain and sustain torque during the calibration process.

Large wheel for smooth manual loading.

Operates in both clockwise and counterclockwise directions.

Models that range from 0 - 2000 lbf.ft

Use with a Mountz BMX transducer and torque analyzer.

Mountable for bench or a cabinet.

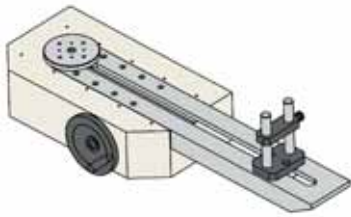

LB250F

Torque Range: Max. 250 lbf.ft (3000 lbf.in).

Reaction Position:
Horizontally: 4" to 28" from the center of the turn-table.
Vertically: 1" to 4" from the turn-table base.

Weight: 53 lbs.

Size: 37.5" W x 12" H x 10.75" D

Item #063302

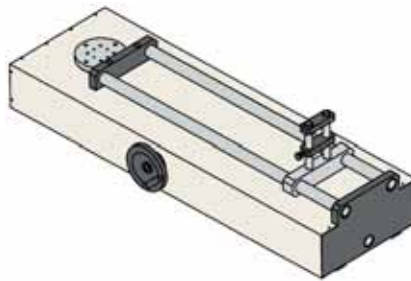

LB750F

Torque Range: Max. 750 lbf.ft (9000 lbf.in).

Reaction Position:
Horizontally: 4.87" to 41.25" from the center of the turn-table.
Vertically: 1.87" to 5.4" from the turn-table base.

Weight: 130 lbs.

Size: 50" W x 15" H x 15.5" D

Item #063301

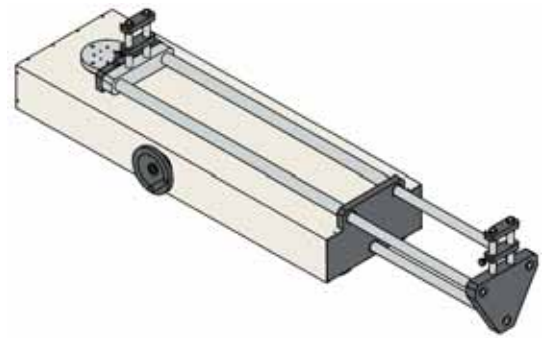

LB2000F

Torque Range: Max. 2000 lbf.ft (24000 lbf.in).

Reaction Position:
Horizontally: 4.87" to 75.5" from the center of the turn-table.
Vertically: 1.87" to 5.4" from the turn-table base.

Weight: 160 lbs.

Size: 84.75" W x 15" H x 15.5" D

Item #063300



NOTE!

It is recommended that the Loading Bench be fastened to a bench top.



WIZARD PLUS TORQUE ANALYZER

The easy to use torque analyzer is ideal for SPC testing & ISO 6789 testing. It features the ability to produce Certificates to ISO 6789:2003.

See Page 01.5



BMX TRANSDUCER

For calibrating manual or power tools or special applications. A wide torque range selection, from 2 ozf.in to 20,000 lbf.ft.

See Page 01.8

Calibrated Dead Weights are the official means by which torque analyzers and transducers are traced to the National or International Standards such as NIST, ISO, and others. There are 3 components that compose of a Dead Weight Test Set: (1) Segment Arm or Wheel, (2) Hanger, and (3) Weights.

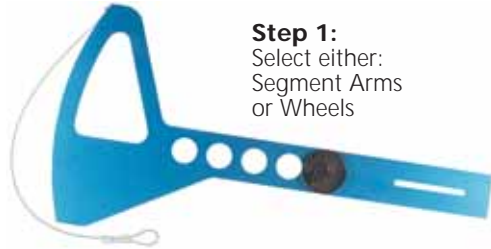

Step 1:
Select either:
Segment Arms
or Wheels

SEGMENT ARMS

Model	Item #	Max Wt.	Tolerance	Input Dr.	Length
S-10	061106	25 lbs.	± .005	1/4"	10"
S-10	060094	75 lbs.	± .005	3/8"	10"
S-10	060056	100 lbs.	± .005	1/2"	10"
S-12	060052	75 lbs.	± .006	3/8"	12"
S-12	060093	100 lbs.	± .006	1/2"	12"
S-24	060091	100 lbs.	± .012	1/2"	24"
S-24	060053	200 lbs.	± .012	3/4"	24"
S-48	060090	125 lbs.	± .024	3/4"	48"
S-48	060054	200 lbs.	± .024	1"	48"

WHEELS (pictured upper right photo)

Model	Item #	Max Wt.	Tolerance	Input Dr.	Radius
1.0*	061587	50 oz.	± .0005	1/4"	1"
2.0**	060095	20 lbs.	± .001	1/4" & 3/8"	2"
4.0**	060064	50 lbs.	± .002	1/4" & 3/8"	4"

*Shape: Circular **Shape: Butterfly



Calibration Test Equipment

For Torque Analyzers & Torque Transducers

Step 2: Select Hangers

Model	Item #	Weight	Stem
Stainless Steel (Class F)	110044	2 lbs.	9 1/4"
Stainless Steel (Class F)	110043	5 lbs.	16"



Step 3: Select Weights



Model	Item #	Weight
Stainless Steel Hook (Class 3)	110050	0.25 oz.
Stainless Steel Hook (Class 3)	110051	0.50 oz.
Stainless Steel Hook (Class 3)	110052	1 oz.
Stainless Steel Hook (Class 3)	110053	2 oz.
Stainless Steel Hook (Class 3)	110054	4 oz.
Stainless Steel Hook (Class 3)	110055	8 oz.
Stainless Steel Hook (Class 3)	110056	16 oz.
Stainless Steel Hook (Class 3)	110057	32 oz.
Stainless Steel Hook (Class 3)	110058	40 oz.
Stainless Steel Slotted (Class F)	110047	0.5 lbs.
Stainless Steel Slotted (Class F)	110046	1 lb.
Stainless Steel Slotted (Class F)	110045	2 lbs.
Stainless Steel Slotted (Class F)	110041	5 lbs.
Stainless Steel Slotted (Class F)	110042	10 lbs.
Stainless Steel Slotted (Class F)	110070	20 lbs.
Stainless Steel Slotted (Class F)	110071	50 lbs.



TOTAL WEIGHT

Weights are placed upon the Hanger, which is hung from the Segment Arm or Wheel. The amount of **total weight** needed is determined by the maximum torque range of the analyzer or transducer being calibrated and the length of the Segment Arm or Wheel.

EZ-TorQ CALIBRATION KIT

The EZ-TorQ analyzer includes the EZ Calibration software for multipoint calibrations. For performing the calibration a calibration wheel, hanger and weights are required.

Mountz offers calibration kits for calibrating the EZ-TorQ. The kits include a wheel, hanger and weights.

**Calibration Kit
EZ-TorQ 10i (American)
Item #061279**

**Calibration Kit
EZ-TorQ 50i & 100i (American)
Item #061280**

NOTE!

Total weight includes both the Hanger and the Stainless Steel Weight(s).

Calibration Stands



In / Out
Adapters

Pin
Adapters

ROTARY FIXTURE STAND

The stand keeps the Rotary Transducer in a stable position for the calibration process.

Supplied with Pin Adapters and In/Out Adapters.

Calibration Wheel(s), Hanger(s), Weight(s), and Torque Analyzer are required for calibration of a Rotary Transducer. See Page 01.18

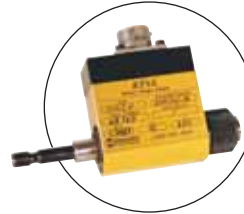

RTSX TRANSDUCER (rotary style)

1 lbf.in - 1500 lbf.ft
For power tools and rotation
measurement.

See Page 01.9

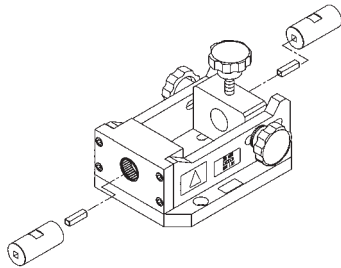

Model: RFS-200
Torque Range: 1 - 200 lbf.in
Dimensions: 5 1/2" x 7 1/4" x 2 3/4"
Item #060234

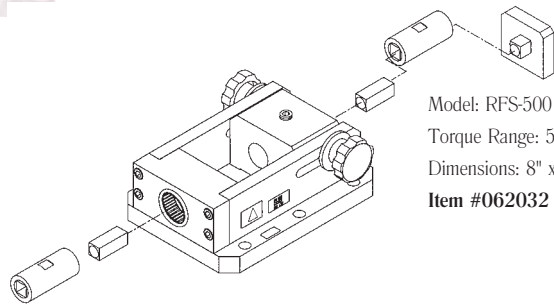

Model: RFS-500
Torque Range: 5 - 500 lbf.ft
Dimensions: 8" x 11" x 4 1/4"
Item #062032

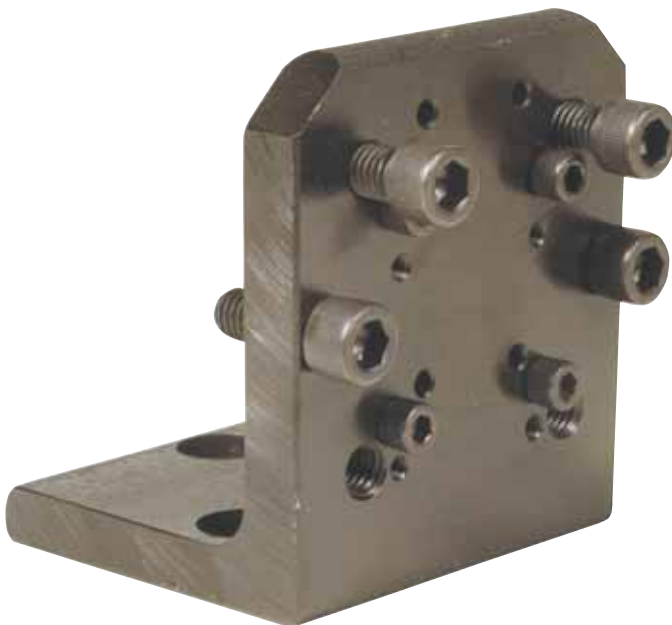

Mounting Brackets

Model: MB-1
Works with: BMX20z - BMX500F
LPX 10z - 20i
All EZ-TorQ Models
Dimensions: 4" x 3" x 4"
Item #062109

Model: MB-3
Works with: BMX1000F - BMX5000F
Dimensions: 8" x 7 7/8" x 8"
Item #062128



BMX CALIBRATION

A BMX transducer is securely mounted for calibrating a torque wrench using a Mounting Bracket. Keeping the transducer in a stable position ensures the accuracy of the torque measurement during operation.

Accessories

Torque Analyzers and Transducers



AURA ADAPTER (Auto Reversing Run Down Adapter)

Ideal for testing and recording the results of power tools with a torque analyzer or sensor. Not recommended for pulse tools.

Operates in clockwise direction only. Once the tool shuts off, the AURA automatically unwinds for the next run down. Eliminates the need to back it out.

Designed to provide consistent and reliable torque readings for use with power driven torque control tools.

Adapter is mounted in-line between tool drive and transducer.

Compact size and lightweight.

Includes two springs to cover the torque range 1 - 50 lbf.in

Model	Item #	Torque Ranges		Drive Output	Drive Input
		Light Spring	Heavy Spring		
AURA	063292	1 - 25 lbf.in	25 - 50 lbf.in	17mm Hex	1/4" F/Sq.
AURA	063293	1 - 25 lbf.in	25 - 50 lbf.in	1/4 M/Sq.	1/4" F/Sq.

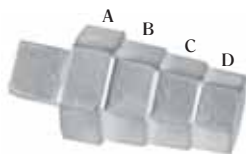

CALIBRATION HEX STEP ADAPTERS

1/4" Square Drive

Model	Item #	Dimensions			
		A	B	C	D
American	061500	3/4"	1 1/16"	5/8"	9/16"
American	061501	1/2"	7/16"	3/8"	5/16"
American	061527	1/2"	3/8"	1/4"	1/8"
American	061502	1/4"	7/32"	3/16"	1/8"
Metric	061503	19mm	17mm	16mm	14mm
Metric	061504	13mm	12mm	11mm	10mm
Metric	061505	9mm	8mm	7mm	6mm
Metric	061529	9mm	7mm	5mm	3mm
Metric	061528	8mm	6mm	4mm	2mm
Metric	061506	5.5mm	5mm	4.5mm	4mm

3/8" Square Drive

Model	Item #	Dimensions			
		A	B	C	D
American	061537	1"	7/8"	3/4"	5/8"
American	061524	3/4"	1 1/16"	5/8"	9/16"
American	061531	9/16"	7/16"	5/16"	3/16"
American	061525	1/2"	7/16"	3/8"	5/16"
American	061530	1/4"	7/32"	3/16"	1/8"
Metric	061543	19mm	17mm	16mm	14mm
Metric	061542	17mm	15mm	13mm	11mm
Metric	061541	16mm	14mm	12mm	10mm
Metric	061540	13mm	12mm	11mm	10mm
Metric	061539	9mm	8mm	7mm	6mm
Metric	061538	5.5mm	5mm	4.5mm	4mm

SPRING RUN DOWN ADAPTERS for EZ-TorQ

Designed to provide consistent and reliable torque readings for use with power driven torque control tools.

Adapter is mounted in-line between tool drive and a transducer.

Compact size and lightweight.

Operates in clockwise direction only.

Compatible with only the EZ-TorQ Analyzer.



Model	Item #	Torque Ranges		Drive Input	Drive Output
		lbf.in	cN.m		
RDA	070600	1 - 10	11.3 - 113	5mm Hex	17mm Hex
RDA	070605	5 - 50	56.5 - 565	6mm Hex	17mm Hex
RDA	070610	10 - 100	113 - 1130	6mm Hex	17mm Hex
RDA	070615	15 - 150	169.5 - 1695	6mm Hex	17mm Hex

RUN DOWN ADAPTERS

Designed to provide consistent and reliable torque readings for use with power driven torque control tools.

Adapter is mounted in-line between tool drive and a transducer.

Hardened thread components increase accuracy and life.

Square drives conform to ASME B107 standards for proper fit.

Non-rotating body for improved safety.

Compact size and lightweight.

Operates in clockwise direction only. After each run down, the RDA should be completely backed-up.



Model	Item #	Torque Ranges		Sq. Drive
		American	S.I.	
RDA-10i	063970	1 - 10 lbf.in	11.3 - 113 cN.m	1/4"
RDA-25i	063971	2 - 25 lbf.in	28 - 282.5 cN.m	1/4"
RDA-50i	063972	5 - 50 lbf.in	56.5 - 565 cN.m	1/4"
RDA-100i	063973	10 - 100 lbf.in	113 - 1130 cN.m	1/4"
RDA-250i	063974	25 - 250 lbf.in	282.5 - 2825 cN.m	1/4"
RDA-50F	063978	5 - 50 lbf.ft	6.8 - 67.8 N.m	3/8"
RDA-750i	063977	75 - 750 lbf.in	847 - 8473 cN.m	3/8"
RDA-100F	063981	10 - 100 lbf.ft	13.6 - 135.6 N.m	1/2"
RDA-250F	063982	25 - 250 lbf.ft	33.9 - 339 N.m	1/2"
RDA-500F	063983	50 - 500 lbf.ft	67.8 - 678 N.m	3/4"
RDA-1000F	063991	100 - 1000 lbf.ft	135.6 - 1355 N.m	1"
RDA-2500F	063990	250 - 2500 lbf.ft	339 - 3389 N.m	1 1/2"
RDA-5000F	063992	500 - 5000 lbf.ft	678 - 6779 N.m	1 1/2"

Multiplexer

for PTT and LTT



MULTIPLEXER

Item #072998
 Size (W x L x H): 6 3/4" x 6 3/4" x 1 3/8"
 Weight: 1.3 lbs.

KEY FEATURES

Connects 1-4 transducers to the Torque Analyzer and switches between the transducers manually or automatically.

Eliminates the need to plug and unplug transducers.

When the PTT or LTT is connected to the Multiplexer it reviews the Multiplexer (Mux) to determine what transducers are connected and downloads the identity and calibration data for each of the attached transducers.

Bar Code Reader

for PTT and LTT



BAR CODE READER Item #072997

KEY FEATURES

Designed to scan Bar Codes on tools and start Tool Tests automatically.

Reduces operational time for users with a large number of Tool Tests stored in the analyzer.

The PTT or LTT are designed to work with this bar code reader.

Operating Multiplexer and Bar Code Reader with PTT or LTT

This combination provides a flexible, time saving solution that reduces the potential for operator error. For users that have many Tool Tests and using multiple torque transducers, these two accessories are the ideal solution for torque testing.



TorqueMate® Wrench

Electronic Torque Wrench

Accuracy ± 1% of reading from 10% to 100% of full scale.

Microprocessor controlled digital memory wrench for delivering precision torque and storing & downloading torque readings.

Ideal for torque measurement and auditing in R&D, QC, a lab, maintenance and production areas.

RS-232 bi-directional USB cable for data transfer - Windows, MS Excel, SPC compatible.
Additional download can be made in ASCII or binary format.

Bi-directional operation with built-in ratchet head.

Programmable pre-sets up to 99 pre-sets of torque or torque & angle* can be programmed on wrench or uploaded from PC (software provided), all with individual minimum and maximum limits or percentage tolerances. Audible and visual alarms signal approach and achievement of preset torque values.

Over torque warning system.

The recalibration period can be set by cycles and/or time.

Can store torque readings with a time and date stamp.

Selectable languages and units of measurement.

For angle models, both torque and angle values are displayed simultaneously.

Model	Measures	Item #	Torque Ranges		Square Drive	Length		Weight	
			lbf.ft	N.m		inches	mm	lbs.	kg.
TMW20	Torque	240150	1.4 - 14	2 - 20	1/4"	16 1/8	410	1.5	0.67
TMW20A	Torque & Angle	240151	1.4 - 14	2 - 20	1/4"	16 1/8	410	1.5	0.67
TMW50	Torque	240152	3.6 - 36	5 - 50	3/8"	16 1/3	415	1.6	0.73
TMW50 A	Torque & Angle	240153	3.6 - 36	5 - 50	3/8"	16 1/3	415	1.6	0.73
TMW100	Torque	240154	7.3 - 73	10 - 100	3/8"	16 1/3	415	1.6	0.73
TMW100A	Torque & Angle	240155	7.3 - 73	10 - 100	1/2"	16 1/3	415	1.6	0.73
TMW150	Torque	240156	11 - 110	15 - 150	1/2"	22 1/2	570	2.6	1.2
TMW150A	Torque & Angle	240157	11 - 110	15 - 150	1/2"	22 1/2	570	2.6	1.2
TMW250	Torque	240158	18 - 180	25 - 250	1/2"	22 1/2	570	2.6	1.2
TMW250A	Torque & Angle	240159	18 - 180	25 - 250	1/2"	22 1/2	570	2.6	1.2

SPECIFICATIONS

Operation Modes Peak, Pre-set, Set, Recall, Upload, Clear, Date, Language, Units, Track, Backlite, Com (First Movement*, Torque & Angle*)

Units ozf.in, lbf.in, lbf.ft, cN.m, N.m, kgf.cm, kgf.m

Alarms Preset Value Approach, Fastener Overload, Range Overload, Mechanical Overload, Low Battery, Memory Full.

Data Memory 2094 values

Power 4 x AA Batteries

Display Digits Four

Languages English, French, German, Italian, Portuguese & Spanish

* For Torque & Angle Models only.



BMX TRANSDUCER

For calibrating manual tools, power tools or special applications.
A wide torque range selection, from 2 ozf.in to 20,000 lbf.ft.



Torque
Wrenches



ASSEMBLY POWER TOOL CATALOG - MC14

Ask a Mountz customer service representative for a copy of our Assembly Power Tool Catalog (76 page). (Available in Print or PDF format only)

- Hand Torque Screwdrivers**
- Electric Torque Screwdrivers**
- Transformers**
- Torque Screwdriver Accessories**
- Adapters, Bits, Bit Holders, Setters, Sockets**



CORPORATE HEADQUARTERS

1080 North 11th Street
San Jose CA 95112
t 408.292.2214
t 800.456.1828
f 408.292.2733
e-mail sales@etorque.com
www.etorque.com

DISTRIBUTION & SERVICE CENTER

19051 Underwood Road
Foley AL 36535
t 251.943.4125
f 251.943.4979

US & CANADA SALES OFFICES

Anaheim, Boston, Charlotte, Chicago, Cleveland, Dallas, El Paso, Los Angeles, Minneapolis, Nashville, Phoenix, Seattle, San Jose, Toronto



TORQUE MULTIPLIER CATALOG - MC14

Ask a Mountz customer service representative for a copy of our Torque Multiplier Catalog (24 page). (Available in PDF format only)

- Hand Torque Multipliers**
- Pneumatic Torque Multipliers**
- Electric Torque Multipliers**
- Accessories**

MOUNTZ MEXICO SA de CV

MAIN OFFICE & SERVICE CENTER

Av. Cristobal Colon #15343
Col. Paseos de Chihuahua
Chihuahua, Chih. Mexico CP 31125
t 614.481.0023
f 614.481.0053

MEXICO SALES OFFICES

Tijuana, Cd. Juarez, Chihuahua, Reynosa, Monterrey, Mexico DF, Guadalajara